



# compile systems



## PROTECTING THE ENVIRONMENT FOR FUTURE GENERATIONS

Our environmental success story began with the challenge to create an office system that would meet today's business requirements while maintaining a firm commitment to save and protect the environment.

Sustainability became a part of the creative focus and development of Compile that incorporates the latest technology and design features to provide excellent performance at a competitive price.

As government and industry environment ratings such as LEEDS & Greenguard become more prevalent, Compile offers designers and architects functional, attractive, and economical office designs that meet these standards.

Evolve Furniture Group is a leader in reducing waste in the manufacturing of its products as well as utilizing recycled materials wherever possible. We make extensive use of recycled plastic and wood waste from other Global factories.

Evolve Furniture Group is committed to the continuous improvement of our environmental systems, the prevention of pollution, and to comply with both the spirit and the letter of all relevant environmental legislation.

Compile Panels are 100% recyclable at the end of their lifespan. Nothing from an Evolve Panel needs to end up in a landfill.

## SUSTAINABILITY INFORMATION

Compile offers fabrics that are made from 100% recycled polyester, which means less waste going to landfills. These fabrics also reduced the demand for petroleum products, and decrease the environmental impacts of processing those petroleum products into polyester.

Compile's epoxy powder coating process involves no liquids and is solvent free. It contains no harmful VOC's or lead. Up to 99% of over sprayed powdered is reclaimed, mixed with virgin powder and reused.

Compile's entire panel is up to 82% recycled.

Compile masonite is up to 85% recycled.

Compile's entire product line is up to 99% recyclable.

**REFERENCES**

Features, Benefits & General Information ..... 3  
 Coding an Order ..... 4-6  
 Textiles & Finishes ..... 92-96  
 Panel COM Form ..... 97  
 Panel Fabric Specification Sheet ..... 98  
 Panel Fabric Sample..... 100  
 Appendix ..... 101  
 Terms & Conditions ..... 102-103  
 Index..... 104-106

**PANELS**

Panels – Technical Information..... 8  
 Panel – Types ..... 9-14  
 Panel Package – Configuration ..... 15  
 Monolithic Panel Packages..... 16-20  
 Segmented Panel Packages..... 21-25  
 Acoustic Panel Packages ..... 26-30  
 Glazed Panel Packages ..... 34-35  
 Partly Glazed Panel Packages ..... 36-38  
 Privacy Glass ..... 38  
 Single Segmented Open Bottom Panel Packages ..... 39-43  
 Mini Panel Kit ..... 43  
 Connectors - Panel Packages..... 44-45  
 Raceway & Knockout Covers ..... 46  
 Posts & Trim Inserts ..... 47  
 Trim Inserts..... 48  
 Post Covers ..... 49-50

**ELECTRICAL**

Electrical – Technical Information ..... 52  
 Electrical – Wire Schematic ..... 53  
 Electrical – Configuration..... 54  
 Power Distribution Housing ..... 55  
 Cables..... 56-57  
 I Connector ..... 57  
 Duplex Receptacle ..... 58  
 Power Entry ..... 58  
 Electrical Box..... 58-59  
 Post Extension..... 58  
 Ceiling Feed..... 58  
 Under Storage Task Lights ..... 59

**WORKSURFACES**

Worksurfaces – Technical Information..... 62  
 Worksurfaces – Configuration ..... 63  
 Rectangular Worksurface ..... 64  
 Curvilinear Worksurface ..... 65  
 Corner Worksurface ..... 66  
 Extended Curved Corner..... 67-68  
 “D” Worksurface..... 69  
 Hatchet Worksurface ..... 69  
 Straight Wedge Worksurfaces ..... 69  
 Quarter Round Panel Worksurface ..... 70  
 Transaction Worksurface ..... 71-72  
 Accessories ..... 73-74

**STORAGE**

Storage – Technical Information ..... 76  
 Storage – Configuration ..... 77  
 Pedestals..... 78-80  
 Overhead Storage ..... 81-82  
 Lateral Files..... 83-84  
 Key Alike Form ..... 85

**ACCESSORIES**

Tack Board..... 86  
 White Marker Board ..... 87  
 Load Bars..... 88  
 Rail Accessories..... 88-89



## PANELS

- Panel Fabric modules consist of Module Frames, Module Interiors and Fabric Skins.

### Fabric

- Fabric offerings include selections woven with 100% recycled yarn.

### Panel Frame

- Typical workstation contains up to 62.2% recycled material.
- Panel is made of 82.3% recycled material.
- Acoustic panels are light tackable with 0.70 NRC and a 26 STC rating.
- Raceway covers are aluminum.
- Aluminum top cap.

### Metal Components/Raceway Finish

- All aluminum components are painted with environmentally friendly epoxy powder.
- Raceway interiors are coated with recycled epoxy powder.
- The entire Compile Panel and the processes used to manufacture it are designed to save and protect the environment. Compile Panels are made from recycled materials and are 99% recyclable.

### Panel Options

- Compile Panels come in 4 heights: 30", 42", 54" and 66".
- Panel widths come in 7 sizes including: 24", 30", 36", 42", 48", 54" and 60".
- Panels conform to CGSB and ANSI/BIFMA standards.
  - This is your assurance that the quality, and performance level of these Panels have been tested to equal or exceed the requirements of the US government.
- Rigid, aluminum Panel Frame is 2 3/8" thick.
- Aluminum Panel Frame combined with easy to assemble "Quick Connect" clips, create a rigid Panel Wall.
- Levelling glides extend 2".
  - Enables the client to deal with severe undulations in the flooring levels of a building.
- Compile makes it easy to select a Panel function that is suitable for your application.
- Compile makes it easy to select a Panel type and height that is suitable for your application.

## VOICE/DATA AND ELECTRICAL POWER

- Voice/data cables can be inserted at the base. 8 wire, 4 circuit electrical capability, 2 utility + 2 dedicated circuits, each with 10 gauge (oversized) neutrals. All circuits can support up to 20 amps (15 CSA).
- Raceway Cover opening sizes conform to the ANSI/TIA/EIA Furniture Opening Standard of 1.345"x 2.680".
- Panels 24" wide include raceway covers with one knockout.
- Panels 30" wide include raceway covers with two knockouts.
- Panels 36"-60" wide include raceway covers with three knockouts.
- Panels and electrical components are CSA/UL approved.
- The base raceway cavity can accommodate 50 Category 5 data cables or 30 Category 5 data cables when the power distribution housings are present.
- No tools are required to install electrical in the Compile Panel System.
- Post extension cable capacities without electric - 30, with electric - 20.

## WORKSURFACES

- 1" thick worksurfaces come in a variety of shapes and sizes. Essentially, they are 24" or 30" deep and are available in 6" increments from 24" to 84" wide.
- Cable scoops located at the back of each Worksurface provide routing of power and data cables.
- This convenient feature, together with a 3/8" gap between the Worksurface and the Panel, allows access to cables without having grommet holes in the Worksurface.
- With this choice of product, we can tailor each installation to your requirements. The addition of custom sizes shows a commitment to client satisfaction that not every manufacturer offers.
- Thermally fused laminate tops are standard.
- All Worksurfaces utilize balanced construction.
- Predrilled holes in worksurfaces enable installer to properly align worksurface.

## STORAGE

- 19", 23" and 29" deep Pedestals. Freestanding and Worksurface supporting options available.
- Drawer divider and pencil tray included in all Freestanding Pedestals containing box drawers. Drawer divider and pencil tray not included in Worksurface Supporting Pedestals.
- Adjustable glides are accessible from the inside of the cabinet.
- Positive and secure locking system on all Pedestals is standard.
- Full height drawer sides are standard on all file drawers. This enables you to hang files from the drawer side so no extra hardware is necessary. File drawers accept letter sized files. Optional file bars are available to file legal and metric sized files.
- Steel construction guarantees the performance of the product over the long term. Welded joints with a

full top, back and base ensure that the Pedestal will sit square and adequately support the Worksurface where necessary.

- Worksurface supporting Pedestals are standard with Compile.
- Shelves feature all metal construction.
- All storage components as well as the Panel Frames are epoxy powder coated.
- Glides enable you to level the cabinet to the floor and or Worksurface. The convenient adjustment feature allows the installer to adjust the height of the cabinet while it is under the Worksurface. This saves time in the installation process.
- For additional security and peace of mind, locks can be keyed alike or master keyed for additional convenience. Standard recessed handle offers uncluttered aesthetic.
- "Environmentally friendly" epoxy powder coat is 15 times more durable in independent testing than a wet paint spray. This helps maintain the look of the product over its many years of service.

## WARRANTIES AND PERFORMANCE

- A Lifetime Warranty
- Non Obsolescence Warranty
- Reduced cost of assembly and reconfiguration
- ISO9001:2008 Registered
- ISO14001:2004 Registered
- GreenGuard Certified
- Level 2 Certified
- ANSI/BIFMA CGSB testing on all products
- For piece of mind over the long term, we cover you with a comprehensive warranty that is supported by our dealer network.
- Some installation companies claim that the Compile Panels System can be installed in half the time it takes to install most of our competitor's segmented panels. This cost saving can amount to thousands of dollars over the lifetime of our furniture.
- Your assurance of consistent quality to an international standard. Evolve Furniture Group is committed to design, manufacture and distribute superior quality office furniture, which meets or exceeds the requirements of our customers.
- Confirmation that Evolve Furniture Group is committed (1) to providing product that, through their entire life cycle, minimize negative environmental impacts on the environment, (2) to continuous improvement to our environmental systems and programs and (3) to comply to all relevant environmental legislation and regulations.
- Compile Panel System can help a company meet LEED requirements for office furniture.
- Compile components are tested to the highest standard in the industry. This is your assurance of quality and longevity.
- Panel textiles, adjustable keyboard mechanisms, task lights and electrical devices = five (5) Years
- Other parts = Lifetime Warranty

Compile products have been coded using alphas that correspond with the product name. This creates an easy-to-remember code. The following breaks down the coding logic and highlights the required code components needed to order within each product category.

**Panels**

**Example:**                      **Product:**                      Compile Fabric Monolithic Panel

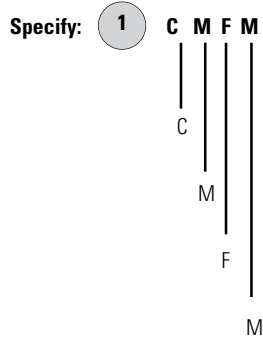

Base Code found on the product page to the left of the product name and a simple product illustration.

**CoM**pile product line

**F**abric-covered Panel

**M**onolithic panel category

**2**    CMFM**6648**

Panel size offering. Listed on every product page with price listing.

Note: Additional dimensions are provided for most products on the far right hand side of each page. These dimensions are not required in the ordering code.

**3**    CMFM6648-**BK**

Standard paint code for frame. See the Fabric & Finish listing in this section.

To specify fabric for a Compile Panel, please note:

**4**    CMFM6648-BK-**B84A**

Fabric code for all modules on both sides of the Panel\*. See the Fabric & Finish listing in this section.

\* **NOTE:** If different fabrics are to be included on a Compile Panel, please use the following ordering format. **Start at the bottom** of one side of a Panel and work to the top module of that Panel. Then start the process over on the other side of the Panel. As an example:

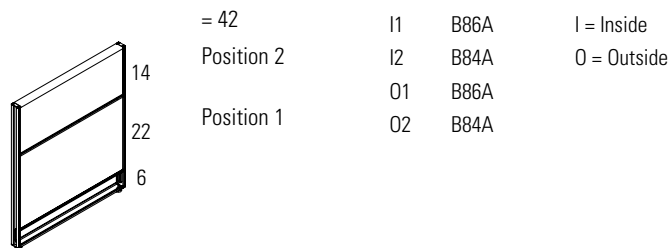

**Electrical**

**Example:**                    **Product:**                    Flexible Mesh Jumper Cable

**Specify:**                    **1**    **C E 8 C P 1 7**

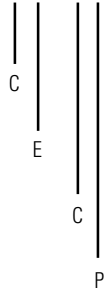

**2**    CE8CP17

Base Code found on the product page to the left of the product name and a simple product illustration.

**C**ompile product line.

**E**lectrical category.

**C**able Panel.

**P**ass-Through.

Product size offering – length. Listed on every product page with price listing. Note: Additional dimensions are provided for most products on the far right hand side of each page. These dimensions are not required in the ordering code.

**Worksurfaces**

**Example:**                    **Product:**                    Curvilinear Worksurface – Left

**Specify:**                    **1**    **C W V L**

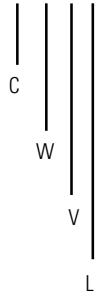

**2**    CWVL3042

**3**    CWVL3042–T431

**4**    CWVL3042–T890–CR

Base Code found on the product page to the left of the product name and a simple product illustration.

**C**ompile product line.

**W**orksurface category.

**C**ur**V**ilinear shape.

**L**eft hand configuration.

Worksurface size offering. Listed on every product page with price listing. Note: Additional dimensions are provided for most products on the far right hand side of each page. These dimensions are not required in the ordering code.

Laminate code for surface. See the Fabric & Finish listing in this section.

PVC code for trim. See the Fabric & Finish listing in this section.

Worksurfaces – Hardware

**Example:**            **Product:**    End Panel

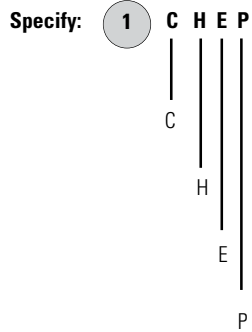

Base Code found on the product page to the left of the product name and a simple product illustration.

**C**ompile product line.

**H**ardware category.

**E**nd Panel.

End **P**anel.

**2**    CHEP-T431

Laminte code for End Panel. See the Fabric & Finish listing in this section.

Storage

**Example:**            **Product:**    Box, Box, File Pedestal

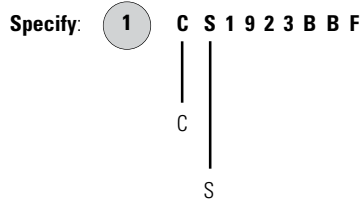

Base Code found on the product page to the left of the product name and a simple product illustration.

**C**ompile product line.

**S**torage category.

**2**    CS1923BBF

**19** Product Series.

**3**    CS1923BBF

**23"** Pedestal depth in inches.

**4**    CS1923BBF

**B**ox drawer, **B**ox drawer, **F**ile drawer.



panels



**THE INFORMATION LISTED BELOW PROVIDES YOU WITH BASIC FEATURES OF COMPILE PANELS:**

- Compile Panels are:
  - Available in four (4) heights: 30", 42", 54" and 66"; and seven (7) widths: 24", 30", 36", 42", 48", 54" and 60".
  - 2 3/8" thick.
  - Monolithic, Segmented, Acoustic, and Glazed.
- Acoustic panels are lightly tackable with 0.70 NRC rating and a 26 STC rating.
- Compile Non - Acoustic panels are not tackable.
- Raceway openings are 1.375" x 2.680".
- Panels 24" wide include raceway covers with one knockout.
- Panels 30" wide include raceway covers with two knockouts.
- Panels 36"-60" wide include raceway covers with three knockouts.
- Opposite sides of each Module may have a different fabric within the same grade at no upcharge.
- If different grades of fabric are used on one panel, the entire panel must be priced at the highest grade.
- Standard with aluminum frame.
- Individual fabric covered acoustic modules incorporated into an aluminum frame.
- Reinforced aluminum raceway covers are included when ordering panel packages or may be ordered and shipped separately. Raceway covers can be replaced in the field to change a panel from non-powered to powered (or vice versa).
- Base raceway lifts up and locks in an upright 90-degree position, or can be removed for open access to base raceway.
- Electric knockouts in the raceway have black plastic covers that snap into place from the outside of the cover, when a duplex is not required. Electric knockout covers must be specified separately. Available in standard paint finishes.
- 3 panel connector brackets per side for 30"h, 42"h and 54"h come installed on panels and universal posts.
- 4 panel connector brackets per side for 66"h panels come installed on panels and universal posts.
- Panel connector brackets are opposite direction of each other per panel side, and can be removed with one screw per bracket.



PANEL PACKAGES - PAGES 16-20

Non-Powered Compile Fabric Monolithic Panel Package

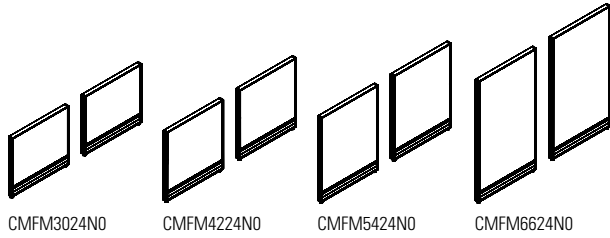

CMFM3024N0    CMFM4224N0    CMFM5424N0    CMFM6624N0

Powered Compile Fabric Monolithic Panel Package

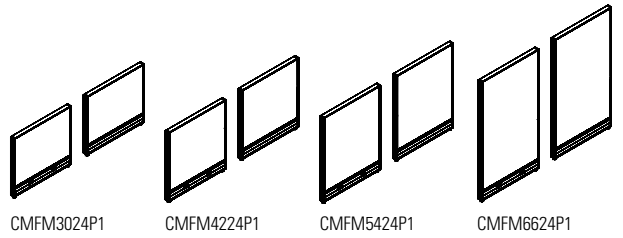

CMFM3024P1    CMFM4224P1    CMFM5424P1    CMFM6624P1

Non-Powered Compile Fabric Monolithic Panel Package

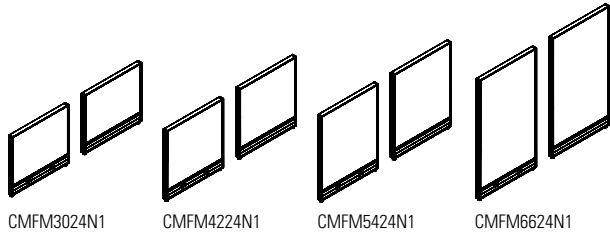

CMFM3024N1    CMFM4224N1    CMFM5424N1    CMFM6624N1

Powered Compile Fabric Monolithic Panel Package

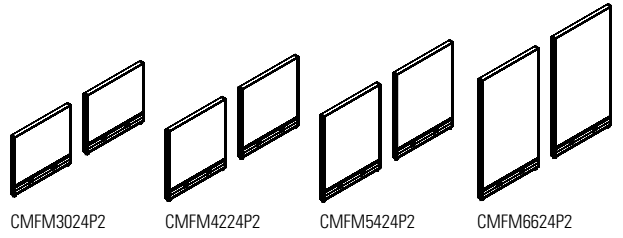

CMFM3024P2    CMFM4224P2    CMFM5424P2    CMFM6624P2

Non-Powered Compile Fabric Monolithic Panel Package

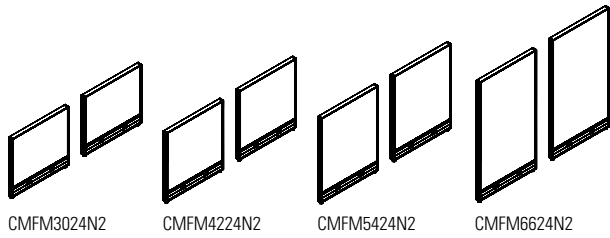

CMFM3024N2    CMFM4224N2    CMFM5424N2    CMFM6624N2

Model Definitions:

- N0 = No punch outs on raceways.
- N1 = Raceway punch out on one side.
- N2 = Raceway punch out on both sides.
- P1 = Power harness and raceway punch out on one side.
- P2 = Power harness and raceway punch outs on two sides.

SEGMENTED - PANEL PACKAGES - PAGES 21-25

Non-Powered Compile Single Segmented Fabric Panel Package

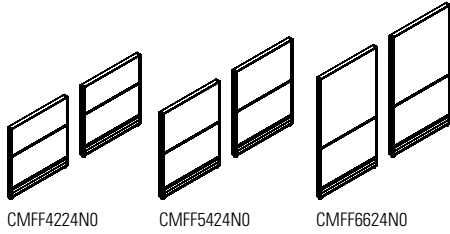

Non-Powered Compile Single Segmented Fabric Panel Package

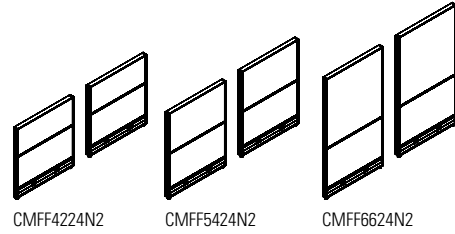

Non-Powered Compile Single Segmented Fabric Panel Package

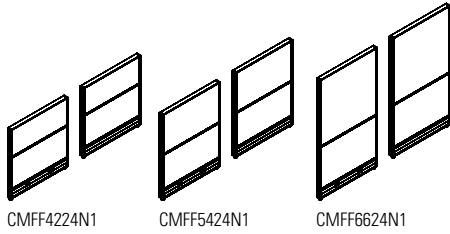

SEGMENTED - PANEL PACKAGES - PAGES 21-25

Powered Compile Single Segmented Fabric Panel Package

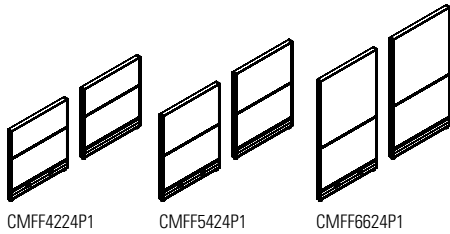

Powered Compile Single Segmented Fabric Panel Package

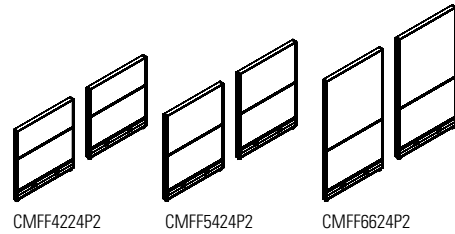

ACOUSTIC PANEL PACKAGES - PAGES 26-30

Non-Powered Compile Monolithic Acoustic Panel Package

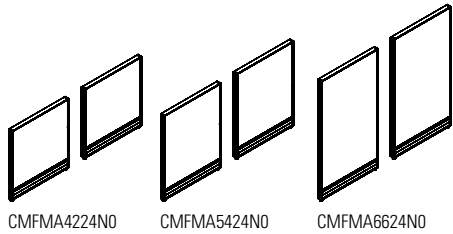

Powered Compile Monolithic Acoustic Panel Package

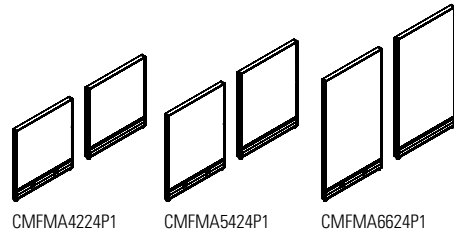

Non-Powered Compile Monolithic Acoustic Panel Package

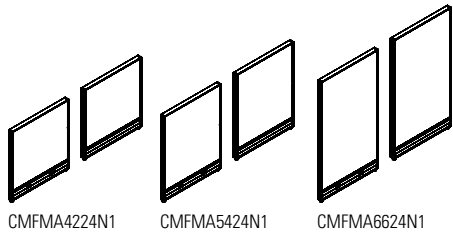

Powered Compile Monolithic Acoustic Panel Package

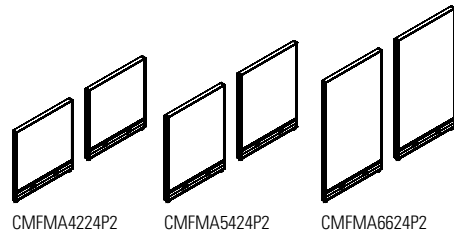

Non-Powered Compile Monolithic Acoustic Panel Package

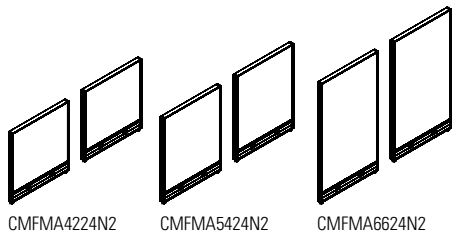

GLAZED PANEL PACKAGES - PAGES 31-35

Non-Powered Compile Glazed Panel Package

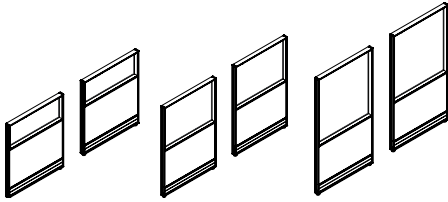

CMFG4224N0

CMFG5424N0

CMFG6624N0

Powered Compile Glazed Panel Package

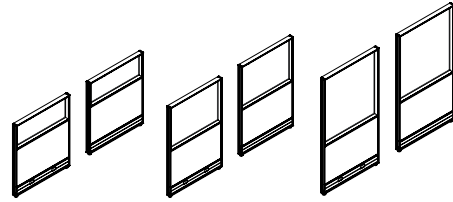

CMFG4224P1

CMFG5424P1

CMFG6624P1

Non-Powered Compile Glazed Panel Package

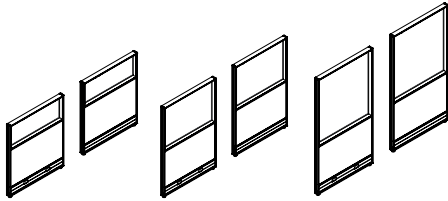

CMFG4224N1

CMFG5424N1

CMFG6624N1

Powered Compile Glazed Panel Package

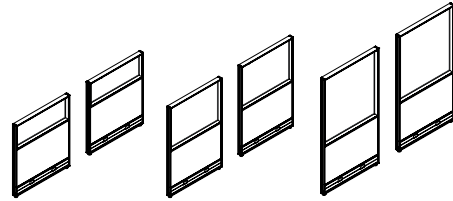

CMFG4224P2

CMFG5424P2

CMFG6624P2

Non-Powered Compile Glazed Panel Package

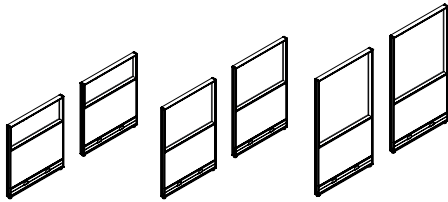

CMFG4224N2

CMFG5424N2

CMFG6624N2



PARTLY GLAZED PANEL PACKAGES - PAGES 36-38

Non-Powered Compile Partly Glazed Premium Panel Package

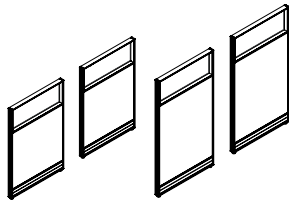

CMPG5424N0

CMPG6624N0

Powered Compile Partly Glazed Premium Panel Package

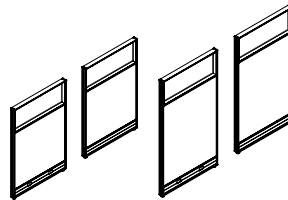

CMPG5424P1

CMPG6624P1

Non-Powered Compile Partly Glazed Premium Panel Package

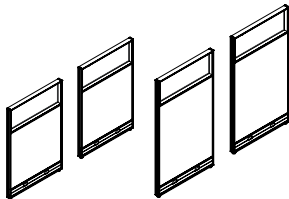

CMPG5424N1

CMPG6624N1

Powered Compile Partly Glazed Premium Panel Package

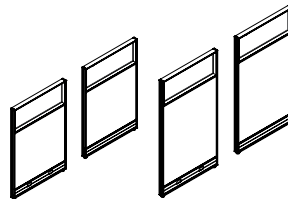

CMPG5424P2

CMPG6624P2

Non-Powered Compile Partly Glazed Premium Panel Package

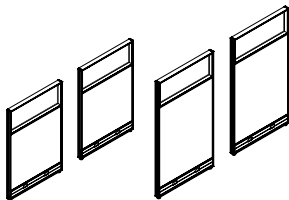

CMPG5424N2

CMPG6624N2

Compile Privacy Glass

Available in widths from 24" to 60".

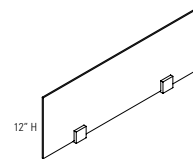

CMPS30

DOOR PANELS - PAGE 39

Sliding Privacy Door

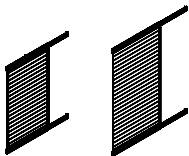

EVPDSL66

EVPDSL81

SINGLE SEGMENTED OPEN BOTTOM PANEL PACKAGES - PAGES 39-43

Non-Powered Compile Single Segmented Open Bottom Panel Package

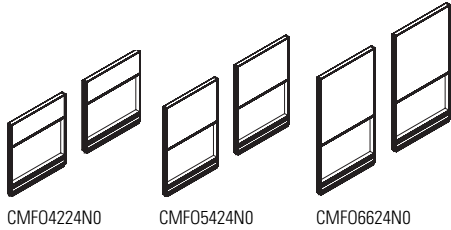

Powered Compile Single Segmented Open Bottom Panel Package

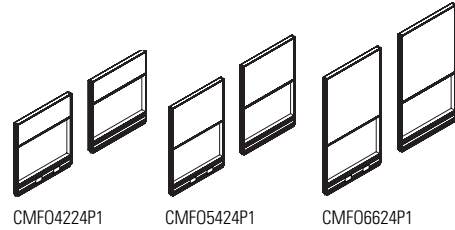

Non-Powered Compile Single Segmented Open Bottom Panel Package

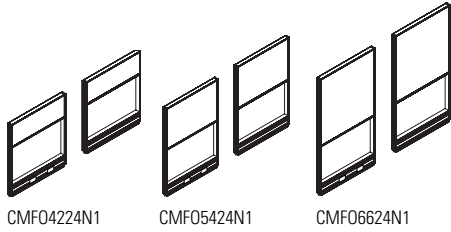

Powered Compile Single Segmented Open Bottom Panel Package

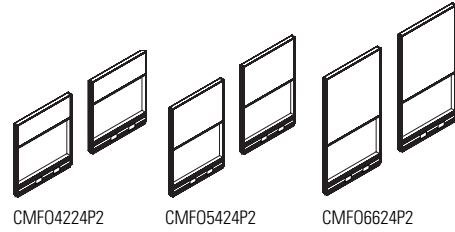

Non-Powered Compile Single Segmented Open Bottom Panel Package

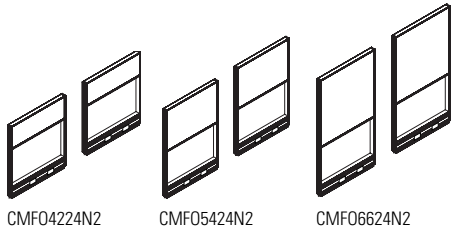

MINI PANEL KIT - PAGE 43

Mini Panel Kit



CMFMA2418KIT1



This page provides an exploded view of a sample Panel Package highlighting each **Panel** component included within the package.

## Package Components

### Package 1 CMFM6636N0

- A. (1) 66" h x 36" w Monolithic Fabric Panel
- B. (2) 36" w Raceway Covers Without Knockouts

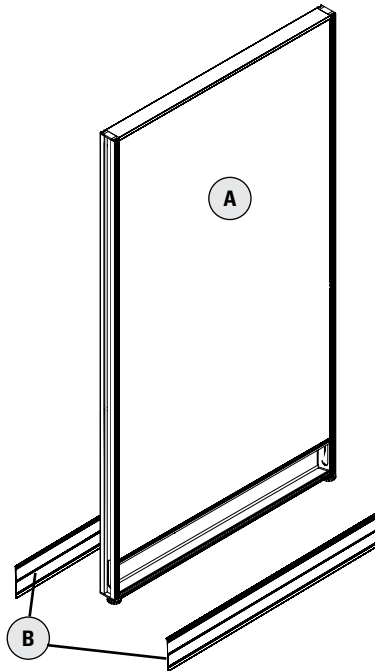

### Package 2 CMFF6636P2

- C. (1) 66" h x 36" w Single Segmented Fabric Panel
- D. (2) 36" w Raceway Covers With Knockouts
- E. (1) 36" w Power Distribution Housing

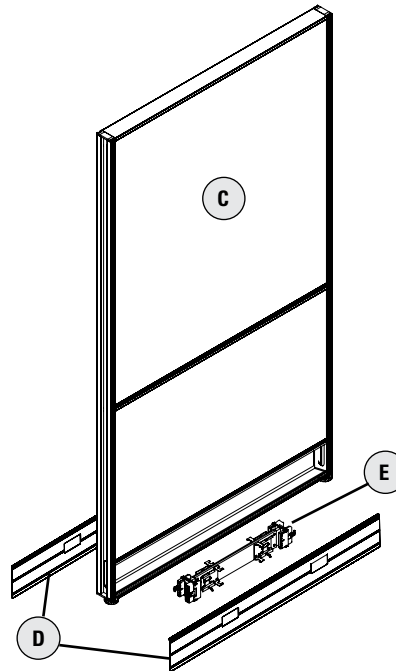

### Package 3 CHP66-2

- F. (1) 66" h Universal Corner Post
- G. (2) Trim Inserts for 66" Universal Corner Post
- H. (1) Post Base Cover for 2-Way Application
- I. "Quick Connect" comes standard with Panels and Universal Corner Post

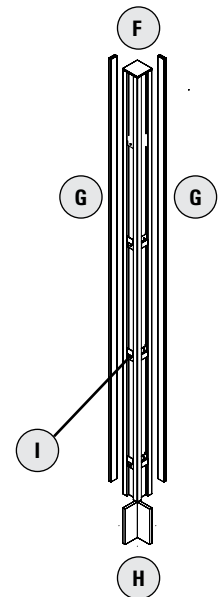



**CMFMXXYYNO - NON-POWERED COMPILE FABRIC MONOLITHIC PANEL PACKAGE**

- Non powered.
- Includes one panel and two raceway covers with no punchouts.
- Individual fabric-covered modules incorporated into an aluminum frame.
- Opposite sides of each module may have a different fabric within the same grade at no upcharge.
- If different grades of fabric are used on one panel, the entire panel must be priced at highest grade.
- Panels are not tackable or acoustical.
- Note: Trim is not required at a straight connection between two panels of the same height.
- 3 Panel connector brackets per side come standard with 30”h, 42”h and 54”h panels.
- 4 Panel connector brackets per side come standard with 66”h panels.
- Panels contain leveling glides. Maximum extension of glides is 2”.

	DESCRIPTION	PRODUCT CODE	LIST PRICE		DIMENSIONS/INCHES		
			Gr1	Gr2	H	W	D
	Non-Powered Compile Fabric Monolithic Panel Package - 30"	CMFM3024NO	251	273	30	24	2 3/8
		CMFM3030NO	284	305	30	30	2 3/8
		CMFM3036NO	309	352	30	36	2 3/8
		CMFM3042NO	341	384	30	42	2 3/8
		CMFM3048NO	363	406	30	48	2 3/8
		CMFM3054NO	401	444	30	54	2 3/8
		CMFM3060NO	423	465	30	60	2 3/8
	Non-Powered Compile Fabric Monolithic Panel Package - 42"	CMFM4224NO	251	273	42	24	2 3/8
		CMFM4230NO	284	305	42	30	2 3/8
		CMFM4236NO	309	352	42	36	2 3/8
		CMFM4242NO	341	384	42	42	2 3/8
		CMFM4248NO	363	406	42	48	2 3/8
		CMFM4254NO	401	444	42	54	2 3/8
		CMFM4260NO	423	465	42	60	2 3/8
	Non-Powered Compile Fabric Monolithic Panel Package - 54"	CMFM5424NO	262	288	54	24	2 3/8
		CMFM5430NO	296	322	54	30	2 3/8
		CMFM5436NO	330	381	54	36	2 3/8
		CMFM5442NO	368	419	54	42	2 3/8
		CMFM5448NO	388	440	54	48	2 3/8
		CMFM5454NO	418	470	54	54	2 3/8
		CMFM5460NO	457	508	54	60	2 3/8
	Non-Powered Compile Fabric Monolithic Panel Package - 66"	CMFM6624NO	293	326	66	24	2 3/8
		CMFM6630NO	337	370	66	30	2 3/8
		CMFM6636NO	385	448	66	36	2 3/8
		CMFM6642NO	433	496	66	42	2 3/8
		CMFM6648NO	469	532	66	48	2 3/8
		CMFM6654NO	522	585	66	54	2 3/8
		CMFM6660NO	572	636	66	60	2 3/8



**CMFMXXYYN1 - NON-POWERED COMPILE FABRIC MONOLITHIC PANEL PACKAGE**

- Non powered.
- Includes one panel, one raceway cover with no punchout and one raceway cover with punchout.
- Individual fabric-covered modules incorporated into an aluminum frame.
- Opposite sides of each module may have a different fabric within the same grade at no upcharge.
- If different grades of fabric are used on one panel, the entire panel must be priced at highest grade.
- Panels are not tackable or acoustical.
- Note: Trim is not required at a straight connection between two panels of the same height.
- 3 Panel connector brackets per side come standard with 30”h, 42”h and 54”h panels.
- 4 Panel connector brackets per side come standard with 66”h panels.
- Panels contain leveling glides. Maximum extension of glides is 2”.

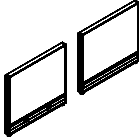
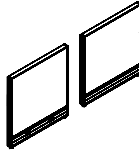
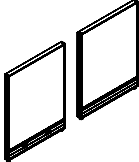
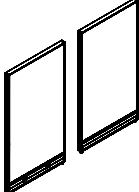
	DESCRIPTION	PRODUCT CODE	LIST PRICE		DIMENSIONS/INCHES		
			Gr1	Gr2	H	W	D
	Non-Powered Compile Fabric Monolithic Panel Package - 30"	CMFM3024N1	251	273	30	24	2 3/8
		CMFM3030N1	284	305	30	30	2 3/8
		CMFM3036N1	309	352	30	36	2 3/8
		CMFM3042N1	341	384	30	42	2 3/8
		CMFM3048N1	363	406	30	48	2 3/8
		CMFM3054N1	401	444	30	54	2 3/8
		CMFM3060N1	423	465	30	60	2 3/8
	Non-Powered Compile Fabric Monolithic Panel Package - 42"	CMFM4224N1	251	273	42	24	2 3/8
		CMFM4230N1	284	305	42	30	2 3/8
		CMFM4236N1	309	352	42	36	2 3/8
		CMFM4242N1	341	384	42	42	2 3/8
		CMFM4248N1	363	406	42	48	2 3/8
		CMFM4254N1	401	444	42	54	2 3/8
		CMFM4260N1	423	465	42	60	2 3/8
	Non-Powered Compile Fabric Monolithic Panel Package - 54"	CMFM5424N1	262	288	54	24	2 3/8
		CMFM5430N1	296	322	54	30	2 3/8
		CMFM5436N1	330	381	54	36	2 3/8
		CMFM5442N1	368	419	54	42	2 3/8
		CMFM5448N1	388	440	54	48	2 3/8
		CMFM5454N1	418	470	54	54	2 3/8
		CMFM5460N1	457	508	54	60	2 3/8
	Non-Powered Compile Fabric Monolithic Panel Package - 66"	CMFM6624N1	293	326	66	24	2 3/8
		CMFM6630N1	337	370	66	30	2 3/8
		CMFM6636N1	385	448	66	36	2 3/8
		CMFM6642N1	433	496	66	42	2 3/8
		CMFM6648N1	469	532	66	48	2 3/8
		CMFM6654N1	522	585	66	54	2 3/8
		CMFM6660N1	572	636	66	60	2 3/8

**CMFMXXYYN2 - NON-POWERED COMPILE FABRIC MONOLITHIC PANEL PACKAGE**

- Non powered.
- Includes one panel and two raceway covers with punchouts.
- Individual fabric-covered modules incorporated into an aluminum frame.
- Opposite sides of each module may have a different fabric within the same grade at no upcharge.
- If different grades of fabric are used on one panel, the entire panel must be priced at highest grade.
- Panels are not tackable or acoustical.
- Note: Trim is not required at a straight connection between two panels of the same height.
- 3 Panel connector brackets per side come standard with 30”h, 42”h and 54”h panels.
- 4 Panel connector brackets per side come standard with 66”h panels.
- Panels contain leveling glides. Maximum extension of glides is 2”.

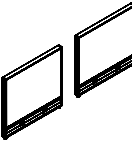
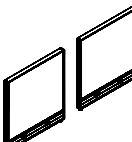
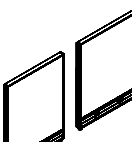
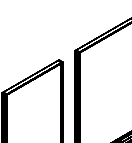
	DESCRIPTION	PRODUCT CODE	LIST PRICE		DIMENSIONS/INCHES		
			Gr1	Gr2	H	W	D
	Non-Powered Compile Fabric Monolithic Panel Package - 30"	CMFM3024N2	251	273	30	24	2 3/8
		CMFM3030N2	284	305	30	30	2 3/8
		CMFM3036N2	309	352	30	36	2 3/8
		CMFM3042N2	341	384	30	42	2 3/8
		CMFM3048N2	363	406	30	48	2 3/8
		CMFM3054N2	401	444	30	54	2 3/8
		CMFM3060N2	423	465	30	60	2 3/8
	Non-Powered Compile Fabric Monolithic Panel Package - 42"	CMFM4224N2	251	273	42	24	2 3/8
		CMFM4230N2	284	305	42	30	2 3/8
		CMFM4236N2	309	352	42	36	2 3/8
		CMFM4242N2	341	384	42	42	2 3/8
		CMFM4248N2	363	406	42	48	2 3/8
		CMFM4254N2	401	444	42	54	2 3/8
		CMFM4260N2	423	465	42	60	2 3/8
	Non-Powered Compile Fabric Monolithic Panel Package - 54"	CMFM5424N2	262	288	54	24	2 3/8
		CMFM5430N2	296	322	54	30	2 3/8
		CMFM5436N2	330	381	54	36	2 3/8
		CMFM5442N2	368	419	54	42	2 3/8
		CMFM5448N2	388	440	54	48	2 3/8
		CMFM5454N2	418	470	54	54	2 3/8
		CMFM5460N2	457	508	54	60	2 3/8
	Non-Powered Compile Fabric Monolithic Panel Package - 66"	CMFM6624N2	293	326	66	24	2 3/8
		CMFM6630N2	337	370	66	30	2 3/8
		CMFM6636N2	385	448	66	36	2 3/8
		CMFM6642N2	433	496	66	42	2 3/8
		CMFM6648N2	469	532	66	48	2 3/8
		CMFM6654N2	522	585	66	54	2 3/8
		CMFM6660N2	572	636	66	60	2 3/8



**CMFMXXYP1 - POWERED COMPILE FABRIC MONOLITHIC PANEL PACKAGE**

- With power distribution harness.
- Includes one panel, power harness, one raceway cover with punchout and one raceway cover with no punchout.
- Individual fabric-covered modules incorporated into an aluminum frame.
- Opposite sides of each module may have a different fabric within the same grade at no upcharge.
- If different grades of fabric are used on one panel, the entire panel must be priced at highest grade.
- Panels are not tackable or acoustical.
- Note: Trim is not required at a straight connection between two panels of the same height.
- 3 Panel connector brackets per side come standard with 30”h, 42”h and 54”h panels.
- 4 Panel connector brackets per side come standard with 66”h panels.
- Panels contain leveling glides. Maximum extension of glides is 2”.

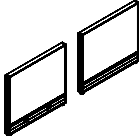
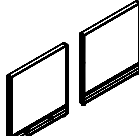
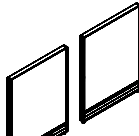
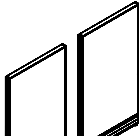
	DESCRIPTION	PRODUCT CODE	LIST PRICE		DIMENSIONS/INCHES		
			Gr1	Gr2	H	W	D
	Powered Compile Fabric Monolithic Panel Package - 30"	CMFM3024P1	357	379	30	24	2 3/8
		CMFM3030P1	427	448	30	30	2 3/8
		CMFM3036P1	459	502	30	36	2 3/8
		CMFM3042P1	494	537	30	42	2 3/8
		CMFM3048P1	528	571	30	48	2 3/8
		CMFM3054P1	567	610	30	54	2 3/8
		CMFM3060P1	590	632	30	60	2 3/8
	Powered Compile Fabric Monolithic Panel Package - 42"	CMFM4224P1	357	379	42	24	2 3/8
		CMFM4230P1	427	448	42	30	2 3/8
		CMFM4236P1	459	502	42	36	2 3/8
		CMFM4242P1	494	537	42	42	2 3/8
		CMFM4248P1	528	571	42	48	2 3/8
		CMFM4254P1	567	610	42	54	2 3/8
		CMFM4260P1	590	632	42	60	2 3/8
	Powered Compile Fabric Monolithic Panel Package - 54"	CMFM5424P1	368	394	54	24	2 3/8
		CMFM5430P1	439	465	54	30	2 3/8
		CMFM5436P1	480	531	54	36	2 3/8
		CMFM5442P1	521	572	54	42	2 3/8
		CMFM5448P1	553	605	54	48	2 3/8
		CMFM5454P1	584	636	54	54	2 3/8
		CMFM5460P1	624	675	54	60	2 3/8
	Powered Compile Fabric Monolithic Panel Package - 66"	CMFM6624P1	399	432	66	24	2 3/8
		CMFM6630P1	480	513	66	30	2 3/8
		CMFM6636P1	535	598	66	36	2 3/8
		CMFM6642P1	586	649	66	42	2 3/8
		CMFM6648P1	634	697	66	48	2 3/8
		CMFM6654P1	688	751	66	54	2 3/8
		CMFM6660P1	739	803	66	60	2 3/8

**CMFMXXYP2 - POWERED COMPILE FABRIC MONOLITHIC PANEL PACKAGE**

- With power distribution harness
  - Includes one panel, power harness, and two raceway covers with punchouts.
  - Individual fabric-covered modules incorporated into an aluminum frame.
  - Opposite sides of each module may have a different fabric within the same grade at no upcharge.
  - If different grades of fabric are used on one panel, the entire panel must be priced at highest grade.
  - Panels are not tackable or acoustical.
- Note: Trim is not required at a straight connection between two panels of the same height.
  - 3 Panel connector brackets per side come standard with 30”h, 42”h and 54”h panels.
  - 4 Panel connector brackets per side come standard with 66”h panels.
  - Panels contain leveling glides. Maximum extension of glides is 2”.

	DESCRIPTION	PRODUCT CODE	LIST PRICE		DIMENSIONS/INCHES		
			Gr1	Gr2	H	W	D
	Powered Compile Fabric Monolithic Panel Package - 30"	CMFM3024P2	357	379	30	24	2 3/8
		CMFM3030P2	427	448	30	30	2 3/8
		CMFM3036P2	459	502	30	36	2 3/8
		CMFM3042P2	494	537	30	42	2 3/8
		CMFM3048P2	528	571	30	48	2 3/8
		CMFM3054P2	567	610	30	54	2 3/8
		CMFM3060P2	590	632	30	60	2 3/8
	Powered Compile Fabric Monolithic Panel Package - 42"	CMFM4224P2	357	379	42	24	2 3/8
		CMFM4230P2	427	448	42	30	2 3/8
		CMFM4236P2	459	502	42	36	2 3/8
		CMFM4242P2	494	537	42	42	2 3/8
		CMFM4248P2	528	571	42	48	2 3/8
		CMFM4254P2	567	610	42	54	2 3/8
		CMFM4260P2	590	632	42	60	2 3/8
	Powered Compile Fabric Monolithic Panel Package - 54"	CMFM5424P2	368	394	54	24	2 3/8
		CMFM5430P2	439	465	54	30	2 3/8
		CMFM5436P2	480	531	54	36	2 3/8
		CMFM5442P2	521	572	54	42	2 3/8
		CMFM5448P2	553	605	54	48	2 3/8
		CMFM5454P2	584	636	54	54	2 3/8
		CMFM5460P2	624	675	54	60	2 3/8
	Powered Compile Fabric Monolithic Panel Package - 66"	CMFM6624P2	399	432	66	24	2 3/8
		CMFM6630P2	480	513	66	30	2 3/8
		CMFM6636P2	535	598	66	36	2 3/8
		CMFM6642P2	586	649	66	42	2 3/8
		CMFM6648P2	634	697	66	48	2 3/8
		CMFM6654P2	688	751	66	54	2 3/8
		CMFM6660P2	739	803	66	60	2 3/8



**CMFFXXYYNO - NON-POWERED COMPILE SINGLE SEGMENTED FABRIC PANEL PACKAGE**

- Non powered.
- Includes one panel, two raceway covers with no punchouts.
- Individual fabric-covered modules incorporated into an aluminum frame.
- Opposite sides of each module may have a different fabric within the same grade at no upcharge.
- If different grades of fabric are used on one panel, the entire panel must be priced at highest grade.
- Panels are not tackable or acoustical.
- Note: Trim is not required at a straight connection between two panels of the same height.
- 3 Panel connector brackets per side come standard with 42”h and 54”h panels.
- 4 Panel connector brackets per side come standard with 66”h panels.
- Panels contain leveling glides. Maximum extension of glides is 2”.

	DESCRIPTION	PRODUCT CODE	LIST PRICE		DIMENSIONS/INCHES		
			Gr1	Gr2	H	W	D
	Non-Power Compile Single Segmented Fabric Panel Package - 42"	CMFF4224NO	263	285	42	24	2 3/8
		CMFF4230NO	296	318	42	30	2 3/8
		CMFF4236NO	314	356	42	36	2 3/8
		CMFF4242NO	358	401	42	42	2 3/8
		CMFF4248NO	382	425	42	48	2 3/8
		CMFF4254NO	426	469	42	54	2 3/8
		CMFF4260NO	455	498	42	60	2 3/8
	Non-Powered Compile Single Segmented Fabric Panel Package - 54"	CMFF5424NO	287	312	54	24	2 3/8
		CMFF5430NO	319	345	54	30	2 3/8
		CMFF5436NO	360	411	54	36	2 3/8
		CMFF5442NO	408	459	54	42	2 3/8
		CMFF5448NO	441	492	54	48	2 3/8
		CMFF5454NO	469	520	54	54	2 3/8
		CMFF5460NO	504	555	54	60	2 3/8
	Non-Powered Compile Single Segmented Fabric Panel Package - 66"	CMFF6624NO	336	369	66	24	2 3/8
		CMFF6630NO	384	417	66	30	2 3/8
		CMFF6636NO	427	490	66	36	2 3/8
		CMFF6642NO	487	550	66	42	2 3/8
		CMFF6648NO	516	579	66	48	2 3/8
		CMFF6654NO	560	623	66	54	2 3/8
		CMFF6660NO	595	658	66	60	2 3/8

**CMFFXXYYN1 - NON-POWERED COMPILE SINGLE SEGMENTED FABRIC PANEL PACKAGE**

- Non powered.
- Includes one panel, one raceway cover with no punchout and one raceway cover with punchout.
- Individual fabric-covered modules incorporated into an aluminum frame.
- Opposite sides of each module may have a different fabric within the same grade at no upcharge.
- If different grades of fabric are used on one panel, the entire panel must be priced at highest grade.
- Panels are not tackable or acoustical.
- Note: Trim is not required at a straight connection between two panels of the same height.
- 3 Panel connector brackets per side come standard with 42”h and 54”h panels.
- 4 Panel connector brackets per side come standard with 66”h panels.
- Panels contain leveling glides. Maximum extension of glides is 2”.

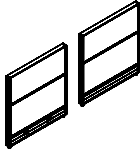
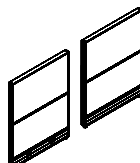
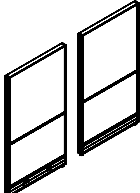
	DESCRIPTION	PRODUCT CODE	LIST PRICE		DIMENSIONS/INCHES		
			Gr1	Gr2	H	W	D
	Non-Powered Compile Single Segmented Fabric Panel Package - 42"	CMFF4224N1	263	285	42	24	2 3/8
		CMFF4230N1	296	318	42	30	2 3/8
		CMFF4236N1	314	356	42	36	2 3/8
		CMFF4242N1	358	401	42	42	2 3/8
		CMFF4248N1	382	425	42	48	2 3/8
		CMFF4254N1	426	469	42	54	2 3/8
		CMFF4260N1	455	498	42	60	2 3/8
	Non-Powered Compile Single Segmented Fabric Panel Package - 54"	CMFF5424N1	287	312	54	24	2 3/8
		CMFF5430N1	319	345	54	30	2 3/8
		CMFF5436N1	360	411	54	36	2 3/8
		CMFF5442N1	408	459	54	42	2 3/8
		CMFF5448N1	441	492	54	48	2 3/8
		CMFF5454N1	469	520	54	54	2 3/8
		CMFF5460N1	504	555	54	60	2 3/8
	Non-Powered Compile Single Segmented Fabric Panel Package - 66"	CMFF6624N1	336	369	66	24	2 3/8
		CMFF6630N1	384	417	66	30	2 3/8
		CMFF6636N1	427	490	66	36	2 3/8
		CMFF6642N1	487	550	66	42	2 3/8
		CMFF6648N1	516	579	66	48	2 3/8
		CMFF6654N1	560	623	66	54	2 3/8
		CMFF6660N1	595	658	66	60	2 3/8



**CMFFXXYYN2 - NON-POWERED COMPILE SINGLE SEGMENTED FABRIC PANEL PACKAGE**

- Non powered.
- Includes one panel, two raceway covers with punchouts.
- Individual fabric-covered modules incorporated into an aluminum frame.
- Opposite sides of each module may have a different fabric within the same grade at no upcharge.
- If different grades of fabric are used on one panel, the entire panel must be priced at highest grade.
- Panels are not tackable or acoustical.
- Note: Trim is not required at a straight connection between two panels of the same height.
- 3 Panel connector brackets per side come standard with 42”h and 54”h panels.
- 4 Panel connector brackets per side come standard with 66”h panels.
- Panels contain leveling glides. Maximum extension of glides is 2”.

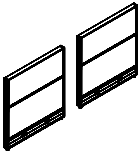
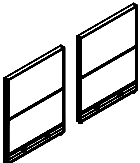
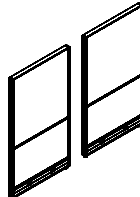
	DESCRIPTION	PRODUCT CODE	LIST PRICE		DIMENSIONS/INCHES		
			Gr1	Gr2	H	W	D
	Non-Power Compile Single Segmented Fabric Panel Package - 42"	CMFF4224N2	263	285	42	24	2 3/8
		CMFF4230N2	296	318	42	30	2 3/8
		CMFF4236N2	314	356	42	36	2 3/8
		CMFF4242N2	358	401	42	42	2 3/8
		CMFF4248N2	382	425	42	48	2 3/8
		CMFF4254N2	426	469	42	54	2 3/8
		CMFF4260N2	455	498	42	60	2 3/8
	Non-Powered Compile Single Segmented Fabric Panel Package - 54"	CMFF5424N2	287	312	54	24	2 3/8
		CMFF5430N2	319	345	54	30	2 3/8
		CMFF5436N2	360	411	54	36	2 3/8
		CMFF5442N2	408	459	54	42	2 3/8
		CMFF5448N2	441	492	54	48	2 3/8
		CMFF5454N2	469	520	54	54	2 3/8
		CMFF5460N2	504	555	54	60	2 3/8
	Non-Powered Compile Single Segmented Fabric Panel Package - 66"	CMFF6624N2	336	369	66	24	2 3/8
		CMFF6630N2	384	417	66	30	2 3/8
		CMFF6636N2	427	490	66	36	2 3/8
		CMFF6642N2	487	550	66	42	2 3/8
		CMFF6648N2	516	579	66	48	2 3/8
		CMFF6654N2	560	623	66	54	2 3/8
		CMFF6660N2	595	658	66	60	2 3/8



**CMFFXXYP1 - POWERED COMPILE SINGLE SEGMENTED FABRIC PANEL PACKAGE**

- With power distribution harness.
- Includes one panel, power harness, one raceway cover with punchout and one raceway cover with no punchout.
- Individual fabric-covered modules incorporated into an aluminum frame.
- Opposite sides of each module may have a different fabric within the same grade at no upcharge.
- If different grades of fabric are used on one panel, the entire panel must be priced at highest grade.
- Panels are not tackable or acoustical.
- Note: Trim is not required at a straight connection between two panels of the same height.
- 3 Panel connector brackets per side come standard with 42”h and 54”h panels.
- 4 Panel connector brackets per side come standard with 66”h panels.
- Panels contain leveling glides. Maximum extension of glides is 2”.

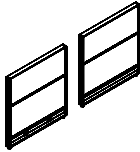
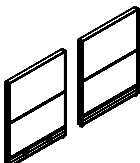
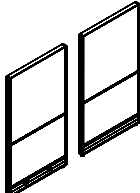
	DESCRIPTION	PRODUCT CODE	LIST PRICE		DIMENSIONS/INCHES		
			Gr1	Gr2	H	W	D
	Powered Compile Single Segmented Fabric Panel Package - 42"	CMFF4224P1	369	391	42	24	2 3/8
		CMFF4230P1	439	461	42	30	2 3/8
		CMFF4236P1	464	506	42	36	2 3/8
		CMFF4242P1	511	554	42	42	2 3/8
		CMFF4248P1	547	590	42	48	2 3/8
		CMFF4254P1	592	635	42	54	2 3/8
		CMFF4260P1	622	665	42	60	2 3/8
	Powered Compile Single Segmented Fabric Panel Package - 54"	CMFF5424P1	393	418	54	24	2 3/8
		CMFF5430P1	462	488	54	30	2 3/8
		CMFF5436P1	510	561	54	36	2 3/8
		CMFF5442P1	561	612	54	42	2 3/8
		CMFF5448P1	606	657	54	48	2 3/8
		CMFF5454P1	635	686	54	54	2 3/8
		CMFF5460P1	671	722	54	60	2 3/8
	Powered Compile Single Segmented Fabric Panel Package - 66"	CMFF6624P1	442	475	66	24	2 3/8
		CMFF6630P1	527	560	66	30	2 3/8
		CMFF6636P1	577	640	66	36	2 3/8
		CMFF6642P1	640	703	66	42	2 3/8
		CMFF6648P1	681	744	66	48	2 3/8
		CMFF6654P1	726	789	66	54	2 3/8
		CMFF6660P1	762	825	66	60	2 3/8



**CMFFXXYP2 - POWERED COMPILE SINGLE SEGMENTED FABRIC PANEL PACKAGE**

- With power distribution harness.
- Includes one panel, power harness, and two raceway cover with punchouts.
- Individual fabric-covered modules incorporated into an aluminum frame.
- Opposite sides of each module may have a different fabric within the same grade at no upcharge.
- If different grades of fabric are used on one panel, the entire panel must be priced at highest grade.
- Panels are not tackable or acoustical.
- Note: Trim is not required at a straight connection between two panels of the same height.
- 3 Panel connector brackets per side come standard with 42”h and 54”h panels.
- 4 Panel connector brackets per side come standard with 66”h panels.
- Panels contain leveling glides. Maximum extension of glides is 2”.

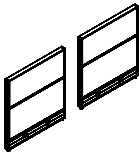
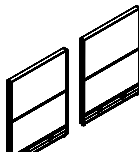
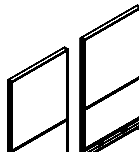
	DESCRIPTION	PRODUCT CODE	LIST PRICE		DIMENSIONS/INCHES		
			Gr1	Gr2	H	W	D
	Powered Compile Single Segmented Fabric Panel Package - 42"	CMFF4224P2	369	391	42	24	2 3/8
		CMFF4230P2	439	461	42	30	2 3/8
		CMFF4236P2	464	506	42	36	2 3/8
		CMFF4242P2	511	554	42	42	2 3/8
		CMFF4248P2	547	590	42	48	2 3/8
		CMFF4254P2	592	635	42	54	2 3/8
		CMFF4260P2	622	665	42	60	2 3/8
	Powered Compile Single Segmented Fabric Panel Package - 54"	CMFF5424P2	393	418	54	24	2 3/8
		CMFF5430P2	462	488	54	30	2 3/8
		CMFF5436P2	510	561	54	36	2 3/8
		CMFF5442P2	561	612	54	42	2 3/8
		CMFF5448P2	606	657	54	48	2 3/8
		CMFF5454P2	635	686	54	54	2 3/8
		CMFF5460P2	671	722	54	60	2 3/8
	Powered Compile Single Segmented Fabric Panel Package - 66"	CMFF6624P2	442	475	66	24	2 3/8
		CMFF6630P2	527	560	66	30	2 3/8
		CMFF6636P2	577	640	66	36	2 3/8
		CMFF6642P2	640	703	66	42	2 3/8
		CMFF6648P2	681	744	66	48	2 3/8
		CMFF6654P2	726	789	66	54	2 3/8
		CMFF6660P2	762	825	66	60	2 3/8

**CMFMAXYYNO - NON-POWERED COMPILE MONOLITHIC ACOUSTIC PANEL PACKAGE**

- Non powered.
- Includes one panel and two raceway covers with no punchouts.
- Individual fabric-covered acoustic modules incorporated into an aluminum frame.
- Opposite sides of each module may have a different fabric within the same grade at no upcharge.
- If different grades of fabric are used on one panel, the entire panel must be priced at highest grade.
- Panels are lightly tackable.
- Note: Trim is not required at a straight connection between two panels of the same height.
- 3 Panel connector brackets per side come standard with 42”h and 54”h panels.
- 4 Panel connector brackets per side come standard with 66”h panels.
- Panels contain leveling glides. Maximum extension of glides is 2”.

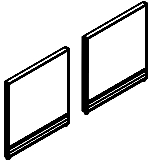
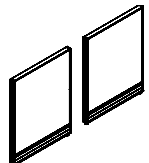
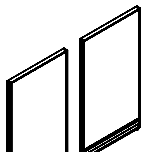
	DESCRIPTION	PRODUCT CODE	LIST PRICE		DIMENSIONS/INCHES		
			Gr1	Gr2	H	W	D
	Non-Powered Compile Monolithic Acoustic Panel Package - 42"	CMFMA4224NO	299	320	42	24	2 3/8
		CMFMA4230NO	336	357	42	30	2 3/8
		CMFMA4236NO	366	409	42	36	2 3/8
		CMFMA4242NO	403	446	42	42	2 3/8
		CMFMA4248NO	428	471	42	48	2 3/8
		CMFMA4254NO	473	516	42	54	2 3/8
		CMFMA4260NO	498	540	42	60	2 3/8
	Non-Powered Compile Monolithic Acoustic Panel Package - 54"	CMFMA5424NO	311	337	54	24	2 3/8
		CMFMA5430NO	351	377	54	30	2 3/8
		CMFMA5436NO	389	441	54	36	2 3/8
		CMFMA5442NO	435	487	54	42	2 3/8
		CMFMA5448NO	459	510	54	48	2 3/8
		CMFMA5454NO	493	545	54	54	2 3/8
		CMFMA5460NO	538	590	54	60	2 3/8
	Non-Powered Compile Monolithic Acoustic Panel Package - 66"	CMFMA6624NO	349	382	66	24	2 3/8
		CMFMA6630NO	400	433	66	30	2 3/8
		CMFMA6636NO	457	520	66	36	2 3/8
		CMFMA6642NO	514	577	66	42	2 3/8
		CMFMA6648NO	555	618	66	48	2 3/8
		CMFMA6654NO	617	681	66	54	2 3/8
		CMFMA6660NO	677	740	66	60	2 3/8



**CMFMAXYYN1 - NON-POWERED COMPILE MONOLITHIC ACOUSTIC PANEL PACKAGE**

- Non powered.
- Includes one panel, one raceway cover with no punchout and one raceway cover with punchout.
- Individual fabric-covered acoustic modules incorporated into an aluminum frame.
- Opposite sides of each module may have a different fabric within the same grade at no upcharge.
- If different grades of fabric are used on one panel, the entire panel must be priced at highest grade.
- Panels are lightly tackable.
- Note: Trim is not required at a straight connection between two panels of the same height.
- 3 Panel connector brackets per side come standard with 42”h and 54”h panels.
- 4 Panel connector brackets per side come standard with 66”h panels.
- Panels contain leveling glides. Maximum extension of glides is 2”.

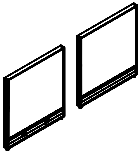
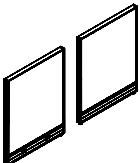
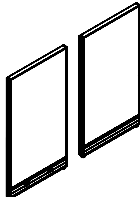
	DESCRIPTION	PRODUCT CODE	LIST PRICE		DIMENSIONS/INCHES		
			Gr1	Gr2	H	W	D
	Non-Powered Compile Monolithic Acoustic Panel Package - 42"	CMFMA4224N1	299	320	42	24	2 3/8
		CMFMA4230N1	336	357	42	30	2 3/8
		CMFMA4236N1	366	409	42	36	2 3/8
		CMFMA4242N1	403	446	42	42	2 3/8
		CMFMA4248N1	428	471	42	48	2 3/8
		CMFMA4254N1	473	516	42	54	2 3/8
		CMFMA4260N1	498	540	42	60	2 3/8
	Non-Powered Compile Monolithic Acoustic Panel Package - 54"	CMFMA5424N1	311	337	54	24	2 3/8
		CMFMA5430N1	351	377	54	30	2 3/8
		CMFMA5436N1	389	441	54	36	2 3/8
		CMFMA5442N1	435	487	54	42	2 3/8
		CMFMA5448N1	459	510	54	48	2 3/8
		CMFMA5454N1	493	545	54	54	2 3/8
		CMFMA5460N1	538	590	54	60	2 3/8
	Non-Powered Compile Acoustic Panel Package - 66"	CMFMA6624N1	349	382	66	24	2 3/8
		CMFMA6630N1	400	433	66	30	2 3/8
		CMFMA6636N1	457	520	66	36	2 3/8
		CMFMA6642N1	514	577	66	42	2 3/8
		CMFMA6648N1	555	618	66	48	2 3/8
		CMFMA6654N1	617	681	66	54	2 3/8
		CMFMA6660N1	677	740	66	60	2 3/8

**CMFMAXYYN2 - NON-POWERED COMPILE MONOLITHIC ACOUSTIC PANEL PACKAGE**

- Non powered.
- Includes one panel and two raceway covers with punchouts.
- Individual fabric-covered acoustic modules incorporated into an aluminum frame.
- Opposite sides of each module may have a different fabric within the same grade at no upcharge.
- If different grades of fabric are used on one panel, the entire panel must be priced at highest grade.
- Panels are lightly tackable.
- Note: Trim is not required at a straight connection between two panels of the same height.
- 3 Panel connector brackets per side come standard with 42”h and 54”h panels.
- 4 Panel connector brackets per side come standard with 66”h panels.
- Panels contain leveling glides. Maximum extension of glides is 2”.

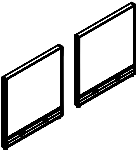
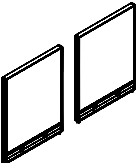
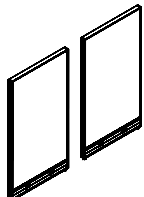
	DESCRIPTION	PRODUCT CODE	LIST PRICE		DIMENSIONS/INCHES		
			Gr1	Gr2	H	W	D
	Non-Powered Compile Monolithic Acoustic Panel Package - 42"	CMFMA4224N2	299	320	42	24	2 3/8
		CMFMA4230N2	336	357	42	30	2 3/8
		CMFMA4236N2	366	409	42	36	2 3/8
		CMFMA4242N2	403	446	42	42	2 3/8
		CMFMA4248N2	428	471	42	48	2 3/8
		CMFMA4254N2	473	516	42	54	2 3/8
		CMFMA4260N2	498	540	42	60	2 3/8
	Non-Powered Compile Monolithic Acoustic Panel Package - 54"	CMFMA5424N2	311	337	54	24	2 3/8
		CMFMA5430N2	351	377	54	30	2 3/8
		CMFMA5436N2	389	441	54	36	2 3/8
		CMFMA5442N2	435	487	54	42	2 3/8
		CMFMA5448N2	459	510	54	48	2 3/8
		CMFMA5454N2	493	545	54	54	2 3/8
		CMFMA5460N2	538	590	54	60	2 3/8
	Non-Powered Compile Monolithic Acoustic Panel Package - 66"	CMFMA6624N2	349	382	66	24	2 3/8
		CMFMA6630N2	400	433	66	30	2 3/8
		CMFMA6636N2	457	520	66	36	2 3/8
		CMFMA6642N2	514	577	66	42	2 3/8
		CMFMA6648N2	555	618	66	48	2 3/8
		CMFMA6654N2	617	681	66	54	2 3/8
		CMFMA6660N2	677	740	66	60	2 3/8



**CMFMAXYYP1 - POWERED COMPILE MONOLITHIC ACOUSTIC PANEL PACKAGE**

- With power distribution harness.
- Includes one panel, power harness, one raceway cover with punchout and one raceway cover with no punchout.
- Individual fabric-covered acoustic modules incorporated into an aluminum frame.
- Opposite sides of each module may have a different fabric within the same grade at no upcharge.
- If different grades of fabric are used on one panel, the entire panel must be priced at highest grade.
- Panels are lightly tackable.
- Note: Trim is not required at a straight connection between two panels of the same height.
- 3 Panel connector brackets per side come standard with 42”h and 54”h panels.
- 4 Panel connector brackets per side come standard with 66”h panels.
- Panels contain leveling glides. Maximum extension of glides is 2”.

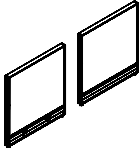
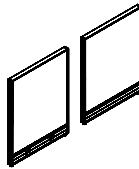
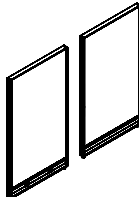
	DESCRIPTION	PRODUCT CODE	LIST PRICE		DIMENSIONS/INCHES		
			Gr1	Gr2	H	W	D
	Powered Compile Monolithic Acoustic Panel Package - 42"	CMFMA4224P1	405	426	42	24	2 3/8
		CMFMA4230P1	479	500	42	30	2 3/8
		CMFMA4236P1	516	559	42	36	2 3/8
		CMFMA4242P1	556	599	42	42	2 3/8
		CMFMA4248P1	593	636	42	48	2 3/8
		CMFMA4254P1	639	682	42	54	2 3/8
		CMFMA4260P1	665	707	42	60	2 3/8
	Powered Compile Monolithic Acoustic Panel Package - 54"	CMFMA5424P1	417	443	54	24	2 3/8
		CMFMA5430P1	494	520	54	30	2 3/8
		CMFMA5436P1	539	591	54	36	2 3/8
		CMFMA5442P1	588	640	54	42	2 3/8
		CMFMA5448P1	624	675	54	48	2 3/8
		CMFMA5454P1	659	711	54	54	2 3/8
		CMFMA5460P1	705	757	54	60	2 3/8
	Powered Compile Monolithic Acoustic Panel Package - 66"	CMFMA6624P1	455	488	66	24	2 3/8
		CMFMA6630P1	543	576	66	30	2 3/8
		CMFMA6636P1	607	670	66	36	2 3/8
		CMFMA6642P1	667	730	66	42	2 3/8
		CMFMA6648P1	720	783	66	48	2 3/8
		CMFMA6654P1	783	847	66	54	2 3/8
		CMFMA6660P1	844	907	66	60	2 3/8

**CMFMAXYP2 - POWERED COMPILE MONOLITHIC ACOUSTIC PANEL PACKAGE**

- With power distribution harness
- Includes one panel, power harness, and two raceway covers with punchouts.
- Individual fabric-covered acoustic modules incorporated into an aluminum frame.
- Opposite sides of each module may have a different fabric within the same grade at no upcharge.
- If different grades of fabric are used on one panel, the entire panel must be priced at highest grade.
- Panels are lightly tackable.
- Note: Trim is not required at a straight connection between two panels of the same height.
- 3 Panel connector brackets per side come standard with 42”h and 54”h panels.
- 4 Panel connector brackets per side come standard with 66”h panels.
- Panels contain leveling glides. Maximum extension of glides is 2”.

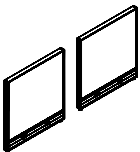
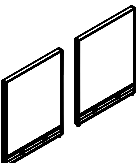
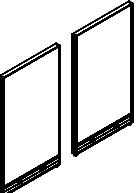
	DESCRIPTION	PRODUCT CODE	LIST PRICE		DIMENSIONS/INCHES		
			Gr1	Gr2	H	W	D
	Powered Compile Monolithic Acoustic Panel Package - 42"	CMFMA4224P2	405	426	42	24	2 3/8
		CMFMA4230P2	479	500	42	30	2 3/8
		CMFMA4236P2	516	559	42	36	2 3/8
		CMFMA4242P2	556	599	42	42	2 3/8
		CMFMA4248P2	593	636	42	48	2 3/8
		CMFMA4254P2	639	682	42	54	2 3/8
		CMFMA4260P2	665	707	42	60	2 3/8
	Powered Compile Monolithic Acoustic Panel Package - 54"	CMFMA5424P2	417	443	54	24	2 3/8
		CMFMA5430P2	494	520	54	30	2 3/8
		CMFMA5436P2	539	591	54	36	2 3/8
		CMFMA5442P2	588	640	54	42	2 3/8
		CMFMA5448P2	624	675	54	48	2 3/8
		CMFMA5454P2	659	711	54	54	2 3/8
		CMFMA5460P2	705	757	54	60	2 3/8
	Powered Compile Monolithic Acoustic Panel Package - 66"	CMFMA6624P2	455	488	66	24	2 3/8
		CMFMA6630P2	543	576	66	30	2 3/8
		CMFMA6636P2	607	670	66	36	2 3/8
		CMFMA6642P2	667	730	66	42	2 3/8
		CMFMA6648P2	720	783	66	48	2 3/8
		CMFMA6654P2	783	847	66	54	2 3/8
		CMFMA6660P2	844	907	66	60	2 3/8



**CMFGXXYYNO - NON-POWERED COMPILE GLAZED PANEL PACKAGE**

- Non powered.
- Includes one panel and two raceway covers with no punchouts.
- Individual fabric-covered module in lower position incorporated into a solid steel frame.
- Opposite sides of each module may have a different fabric within the same grade at no upcharge.
- If different grades of fabric are used on one panel, the entire panel must be priced at highest grade.
- Panels are not tackable or acoustical.
- Trim is not required at a straight connection between two panels of the same height.
- 3 Panel connector brackets per side come standard with 42”h and 54”h panels.
- 4 Panel connector brackets per side come standard with 66”h panels.
- Panels contain leveling glides. Maximum extension of glides is 2”.
- Standard clear (CLR) plexi.
- Optional Smoked Plexi-Glass or Frosted Plexi with 15% upcharge.
- PVC glass retainer in matching paint color.

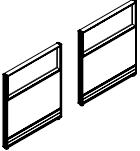
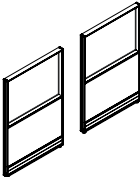
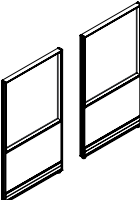
	DESCRIPTION	PRODUCT CODE	LIST PRICE		DIMENSIONS/INCHES		
			Gr1	Gr2	H	W	D
	Non-Powered Compile Glazed Panel Package - 42"	CMFG4224NO	330	340	42	24	2 3/8
		CMFG4230NO	377	389	42	30	2 3/8
		CMFG4236NO	422	438	42	36	2 3/8
		CMFG4242NO	471	489	42	42	2 3/8
		CMFG4248NO	516	535	42	48	2 3/8
		CMFG4254NO	580	601	42	54	2 3/8
		CMFG4260NO	640	664	42	60	2 3/8
	Non-Powered Compile Glazed Panel Package - 54"	CMFG5424NO	356	368	54	24	2 3/8
		CMFG5430NO	417	430	54	30	2 3/8
		CMFG5436NO	474	490	54	36	2 3/8
		CMFG5442NO	533	550	54	42	2 3/8
		CMFG5448NO	580	600	54	48	2 3/8
		CMFG5454NO	676	698	54	54	2 3/8
		CMFG5460NO	765	791	54	60	2 3/8
	Non-Powered Compile Glazed Panel Package - 66"	CMFG6624NO	447	464	66	24	2 3/8
		CMFG6630NO	520	540	66	30	2 3/8
		CMFG6636NO	593	615	66	36	2 3/8
		CMFG6642NO	668	696	66	42	2 3/8
		CMFG6648NO	725	755	66	48	2 3/8
		CMFG6654NO	838	871	66	54	2 3/8
		CMFG6660NO	948	983	66	60	2 3/8



**CMFGXYYN1 - NON-POWERED COMPILE GLAZED PANEL PACKAGE**

- Non powered.
- Includes one panel, one raceway cover with no punchout and one raceway cover with punchout.
- Individual fabric-covered modules incorporated into an aluminum frame.
- Opposite sides of each module may have a different fabric within the same grade at no upcharge.
- If different grades of fabric are used on one panel, the entire panel must be priced at highest grade.
- Panels are not tackable or acoustical.
- Trim is not required at a straight connection between two panels of the same height.
- 3 Panel connector brackets per side come standard with 42”h and 54”h panels.
- 4 Panel connector brackets per side come standard with 66”h panels.
- Panels contain leveling glides. Maximum extension of glides is 2”.
- Standard clear (CLR) plexi.
- Optional Smoked Plexi-Glass or Frosted Plexi with 15% upcharge.
- PVC glass retainer in matching paint color.

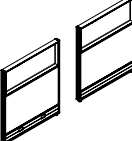
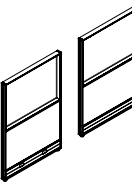
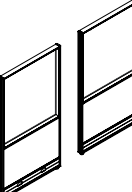
	DESCRIPTION	PRODUCT CODE	LIST PRICE		DIMENSIONS/INCHES		
			Gr1	Gr2	H	W	D
	Non-Powered Compile Glazed Panel Package - 42"	CMFG4224N1	330	340	42	24	2 3/8
		CMFG4230N1	377	389	42	30	2 3/8
		CMFG4236N1	422	438	42	36	2 3/8
		CMFG4242N1	471	489	42	42	2 3/8
		CMFG4248N1	516	535	42	48	2 3/8
		CMFG4254N1	580	601	42	54	2 3/8
		CMFG4260N1	640	664	42	60	2 3/8
	Non-Powered Compile Glazed Panel Package - 54"	CMFG5424N1	356	368	54	24	2 3/8
		CMFG5430N1	417	430	54	30	2 3/8
		CMFG5436N1	474	490	54	36	2 3/8
		CMFG5442N1	533	550	54	42	2 3/8
		CMFG5448N1	580	600	54	48	2 3/8
		CMFG5454N1	676	698	54	54	2 3/8
		CMFG5460N1	765	791	54	60	2 3/8
	Non-Powered Compile Glazed Panel Package - 66"	CMFG6624N1	447	464	66	24	2 3/8
		CMFG6630N1	520	540	66	30	2 3/8
		CMFG6636N1	593	615	66	36	2 3/8
		CMFG6642N1	668	696	66	42	2 3/8
		CMFG6648N1	725	755	66	48	2 3/8
		CMFG6654N1	838	871	66	54	2 3/8
		CMFG6660N1	948	983	66	60	2 3/8



**CMFGXYYN2 - NON-POWERED COMPILE GLAZED PANEL PACKAGE**

- Non powered.
- Includes one panel and two raceway covers with punchouts.
- Individual fabric-covered modules incorporated into an aluminum frame.
- Opposite sides of each module may have a different fabric within the same grade at no upcharge.
- If different grades of fabric are used on one panel, the entire panel must be priced at highest grade.
- Panels are not tackable or acoustical.
- Trim is not required at a straight connection between two panels of the same height.
- 3 Panel connector brackets per side come standard with 42”h and 54”h panels.
- 4 Panel connector brackets per side come standard with 66”h panels.
- Panels contain leveling glides. Maximum extension of glides is 2”.
- Standard clear (CLR) plexi.
- Optional Smoked Plexi-Glass or Frosted Plexi with 15% upcharge.
- PVC glass retainer in matching paint color.

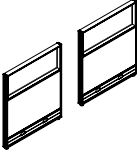
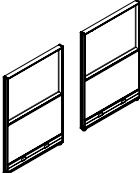
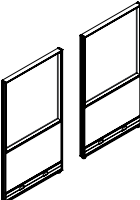
	DESCRIPTION	PRODUCT CODE	LIST PRICE		DIMENSIONS/INCHES		
			Gr1	Gr2	H	W	D
	Non-Powered Compile Glazed Panel Package - 42"	CMFG4224N2	330	340	42	24	2 3/8
		CMFG4230N2	377	389	42	30	2 3/8
		CMFG4236N2	422	438	42	36	2 3/8
		CMFG4242N2	471	489	42	42	2 3/8
		CMFG4248N2	516	535	42	48	2 3/8
		CMFG4254N2	580	601	42	54	2 3/8
		CMFG4260N2	640	664	42	60	2 3/8
	Non-Powered Compile Glazed Panel Package - 54"	CMFG5424N2	356	368	54	24	2 3/8
		CMFG5430N2	417	430	54	30	2 3/8
		CMFG5436N2	474	490	54	36	2 3/8
		CMFG5442N2	533	550	54	42	2 3/8
		CMFG5448N2	580	600	54	48	2 3/8
		CMFG5454N2	676	698	54	54	2 3/8
		CMFG5460N2	765	791	54	60	2 3/8
	Non-Powered Compile Glazed Panel Package - 66"	CMFG6624N2	447	464	66	24	2 3/8
		CMFG6630N2	520	540	66	30	2 3/8
		CMFG6636N2	593	615	66	36	2 3/8
		CMFG6642N2	668	696	66	42	2 3/8
		CMFG6648N2	725	755	66	48	2 3/8
		CMFG6654N2	838	871	66	54	2 3/8
		CMFG6660N2	948	983	66	60	2 3/8

**CMFGXXYP1 - POWERED COMPILE GLAZED PANEL PACKAGE**

- With power distribution harness.
- Includes one panel, power harness, one raceway cover with punchout and one raceway cover with no punchout.
- Individual fabric-covered modules incorporated into an aluminum frame.
- Opposite sides of each module may have a different fabric within the same grade at no upcharge.
- If different grades of fabric are used on one panel, the entire panel must be priced at highest grade.
- Panels are not tackable or acoustical.
- Trim is not required at a straight connection between two panels of the same height.
- 3 Panel connector brackets per side come standard with 42”h and 54”h panels.
- 4 Panel connector brackets per side come standard with 66”h panels.
- Panels contain leveling glides. Maximum extension of glides is 2”.
- Standard clear (CLR) plexi.
- Optional Smoked Plexi-Glass or Frosted Plexi with 15% upcharge.
- PVC glass retainer in matching paint color.

	DESCRIPTION	PRODUCT CODE	LIST PRICE		DIMENSIONS/INCHES		
			Gr1	Gr2	H	W	D
	Powered Compile Glazed Panel Package - 42"	CMFG4224P1	436	446	42	24	2 3/8
		CMFG4230P1	520	532	42	30	2 3/8
		CMFG4236P1	572	588	42	36	2 3/8
		CMFG4242P1	624	642	42	42	2 3/8
		CMFG4248P1	681	700	42	48	2 3/8
		CMFG4254P1	746	767	42	54	2 3/8
	Powered Compile Glazed Panel Package - 54"	CMFG5424P1	462	474	54	24	2 3/8
		CMFG5430P1	560	573	54	30	2 3/8
		CMFG5436P1	624	641	54	36	2 3/8
		CMFG5442P1	686	703	54	42	2 3/8
		CMFG5448P1	745	765	54	48	2 3/8
		CMFG5454P1	842	864	54	54	2 3/8
	Powered Compile Glazed Panel Package - 66"	CMFG6624P1	553	570	66	24	2 3/8
		CMFG6630P1	663	683	66	30	2 3/8
		CMFG6636P1	743	765	66	36	2 3/8
		CMFG6642P1	821	849	66	42	2 3/8
		CMFG6648P1	890	920	66	48	2 3/8
		CMFG6654P1	1004	1037	66	54	2 3/8
		CMFG6660P1	1115	1150	66	60	2 3/8



**CMFGXXYP2 - POWERED COMPILE GLAZED PANEL PACKAGE**

- With power distribution harness
- Includes one panel, power harness, and two raceway covers with punchouts.
- Individual fabric-covered modules incorporated into an aluminum frame.
- Opposite sides of each module may have a different fabric within the same grade at no upcharge.
- If different grades of fabric are used on one panel, the entire panel must be priced at highest grade.
- Panels are not tackable or acoustical.
- Trim is not required at a straight connection between two panels of the same height.
- 3 Panel connector brackets per side come standard with 42”h and 54”h panels.
- 4 Panel connector brackets per side come standard with 66”h panels.
- Panels contain leveling glides. Maximum extension of glides is 2”.
- Standard clear (CLR) plexi.
- Optional Smoked Plexi-Glass or Frosted Plexi with 15% upcharge.
- PVC glass retainer in matching paint color.

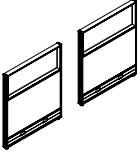
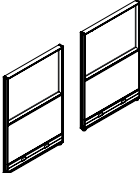
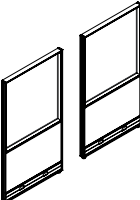
	DESCRIPTION	PRODUCT CODE	LIST PRICE		DIMENSIONS/INCHES		
			Gr1	Gr2	H	W	D
	Powered Compile Glazed Panel Package - 42"	CMFG4224P2	436	446	42	24	2 3/8
		CMFG4230P2	520	532	42	30	2 3/8
		CMFG4236P2	572	588	42	36	2 3/8
		CMFG4242P2	624	642	42	42	2 3/8
		CMFG4248P2	681	700	42	48	2 3/8
		CMFG4254P2	746	767	42	54	2 3/8
	Powered Compile Glazed Panel Package - 54"	CMFG5424P2	462	474	54	24	2 3/8
		CMFG5430P2	560	573	54	30	2 3/8
		CMFG5436P2	624	641	54	36	2 3/8
		CMFG5442P2	686	703	54	42	2 3/8
		CMFG5448P2	745	765	54	48	2 3/8
		CMFG5454P2	842	864	54	54	2 3/8
	Powered Compile Glazed Panel Package - 66"	CMFG6624P2	553	570	66	24	2 3/8
		CMFG6630P2	663	683	66	30	2 3/8
		CMFG6636P2	743	765	66	36	2 3/8
		CMFG6642P2	821	849	66	42	2 3/8
		CMFG6648P2	890	920	66	48	2 3/8
		CMFG6654P2	1004	1037	66	54	2 3/8
		CMFG6660P2	1115	1150	66	60	2 3/8

**CMPGXYYNO - NON-POWERED COMPILE PARTLY GLAZED PANEL PACKAGE**

- Non powered.
- Includes one panel and two raceway covers with no punchouts.
- Individual fabric-covered module in lower position incorporated into a solid steel frame.
- Opposite sides of each module may have a different fabric within the same grade at no upcharge.
- If different grades of fabric are used on one panel, the entire panel must be priced at highest grade.
- Panels are not tackable or acoustical.
- Trim is not required at a straight connection between two panels of the same height.
- 3 Panel connector brackets per side come standard with 54”h panels.
- 4 Panel connector brackets per side come standard with 66”h panels.
- Panels contain leveling glides. Maximum extension of glides is 2”.
- Standard clear (CLR) plexi.
- Optional Smoked Plexi-Glass or Frosted Plexi with 15% upcharge.
- PVC glass retainer in matching paint color.

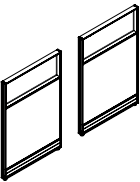
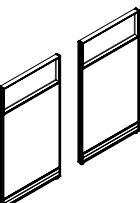
	DESCRIPTION	PRODUCT CODE	LIST PRICE		DIMENSIONS/INCHES		
			Gr1	Gr2	H	W	D
	Non-Powered Compile Partly Glazed Panel Package - 54"	CMPG5424NO	380	408	54	24	2 3/8
		CMPG5430NO	438	474	54	30	2 3/8
		CMPG5436NO	489	526	54	36	2 3/8
		CMPG5442NO	544	590	54	42	2 3/8
		CMPG5448NO	601	656	54	48	2 3/8
		CMPG5454NO	663	721	54	54	2 3/8
		CMPG5460NO	721	785	54	60	2 3/8
	Non-Powered Compile Partly Glazed Panel Package - 66"	CMPG6624NO	416	446	66	24	2 3/8
		CMPG6630NO	478	515	66	30	2 3/8
		CMPG6636NO	536	633	66	36	2 3/8
		CMPG6642NO	597	643	66	42	2 3/8
		CMPG6648NO	660	714	66	48	2 3/8
		CMPG6654NO	728	784	66	54	2 3/8
		CMPG6660NO	792	854	66	60	2 3/8

**CMPGXYYN1 - NON-POWERED COMPILE PARTLY GLAZED PANEL PACKAGE**

- Non powered.
- Includes one panel, one raceway cover with no punchout and one raceway cover with punchout.
- Individual fabric-covered modules incorporated into an aluminum frame.
- Opposite sides of each module may have a different fabric within the same grade at no upcharge.
- If different grades of fabric are used on one panel, the entire panel must be priced at highest grade.
- Panels are not tackable or acoustical.
- Trim is not required at a straight connection between two panels of the same height.
- 3 Panel connector brackets per side come standard with 54”h panels.
- 4 Panel connector brackets per side come standard with 66”h panels.
- Panels contain leveling glides. Maximum extension of glides is 2”.
- Standard clear (CLR) plexi.
- Optional Smoked Plexi-Glass or Frosted Plexi with 15% upcharge.
- PVC glass retainer in matching paint color.

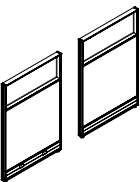
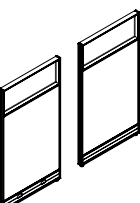
	DESCRIPTION	PRODUCT CODE	LIST PRICE		DIMENSIONS/INCHES		
			Gr1	Gr2	H	W	D
	Non-Powered Compile Partly Glazed Panel Package - 54"	CMPG5424N1	380	408	54	24	2 3/8
		CMPG5430N1	438	474	54	30	2 3/8
		CMPG5436N1	489	526	54	36	2 3/8
		CMPG5442N1	544	590	54	42	2 3/8
		CMPG5448N1	601	656	54	48	2 3/8
		CMPG5454N1	663	721	54	54	2 3/8
		CMPG5460N1	721	785	54	60	2 3/8
	Non-Powered Compile Partly Glazed Panel Package - 66"	CMPG6624N1	416	446	66	24	2 3/8
		CMPG6630N1	478	515	66	30	2 3/8
		CMPG6636N1	536	633	66	36	2 3/8
		CMPG6642N1	597	643	66	42	2 3/8
		CMPG6648N1	660	714	66	48	2 3/8
		CMPG6654N1	728	784	66	54	2 3/8
		CMPG6660N1	792	854	66	60	2 3/8



**CMPGXXYYN2 - NON-POWERED COMPILE PARTLY GLAZED PANEL PACKAGE**

- Non powered.
- Includes one panel and two raceway covers with punchouts.
- Individual fabric-covered modules incorporated into an aluminum frame.
- Opposite sides of each module may have a different fabric within the same grade at no upcharge.
- If different grades of fabric are used on one panel, the entire panel must be priced at highest grade.
- Panels are not tackable or acoustical.
- Trim is not required at a straight connection between two panels of the same height.
- 3 Panel connector brackets per side come standard with 54”h panels.
- 4 Panel connector brackets per side come standard with 66”h panels.
- Panels contain leveling glides. Maximum extension of glides is 2”.
- Standard clear (CLR) plexi.
- Optional Smoked Plexi-Glass or Frosted Plexi with 15% upcharge.
- PVC glass retainer in matching paint color.

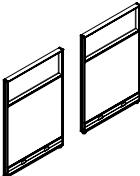
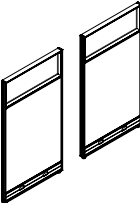
	DESCRIPTION	PRODUCT CODE	LIST PRICE		DIMENSIONS/INCHES		
			Gr1	Gr2	H	W	D
	Non-Powered Compile Partly Glazed Panel Package - 54"	CMPG5424N2	380	408	54	24	2 3/8
		CMPG5430N2	438	474	54	30	2 3/8
		CMPG5436N2	489	526	54	36	2 3/8
		CMPG5442N2	544	590	54	42	2 3/8
		CMPG5448N2	601	656	54	48	2 3/8
		CMPG5454N2	663	721	54	54	2 3/8
		CMPG5460N2	721	785	54	60	2 3/8
	Non-Powered Compile Partly Glazed Panel Package - 66"	CMPG6624N2	416	446	66	24	2 3/8
		CMPG6630N2	478	515	66	30	2 3/8
		CMPG6636N2	536	633	66	36	2 3/8
		CMPG6642N2	597	643	66	42	2 3/8
		CMPG6648N2	660	714	66	48	2 3/8
		CMPG6654N2	728	784	66	54	2 3/8
		CMPG6660N2	792	854	66	60	2 3/8

**CMPGXXYP1 - POWERED COMPILE PARTLY GLAZED PANEL PACKAGE**

- With power distribution harness.
- Includes one panel, power harness, one raceway cover with punchout and one raceway cover with no punchout.
- Individual fabric-covered modules incorporated into an aluminum frame.
- Opposite sides of each module may have a different fabric within the same grade at no upcharge.
- If different grades of fabric are used on one panel, the entire panel must be priced at highest grade.
- Panels are not tackable or acoustical.
- Trim is not required at a straight connection between two panels of the same height.
- 3 Panel connector brackets per side come standard with 54”h panels.
- 4 Panel connector brackets per side come standard with 66”h panels.
- Panels contain leveling glides. Maximum extension of glides is 2”.
- Standard clear (CLR) plexi.
- Optional Smoked Plexi-Glass or Frosted Plexi with 15% upcharge.
- PVC glass retainer in matching paint color.

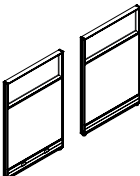
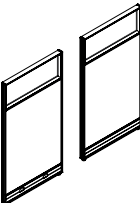
	DESCRIPTION	PRODUCT CODE	LIST PRICE		DIMENSIONS/INCHES		
			Gr1	Gr2	H	W	D
	Powered Compile Partly Glazed Panel Package - 54"	CMPG5424P1	486	514	54	24	2 3/8
		CMPG5430P1	581	617	54	30	2 3/8
		CMPG5436P1	639	676	54	36	2 3/8
		CMPG5442P1	697	743	54	42	2 3/8
		CMPG5448P1	766	821	54	48	2 3/8
		CMPG5454P1	829	887	54	54	2 3/8
		CMPG5460P1	888	952	54	60	2 3/8
	Powered Compile Partly Glazed Panel Package - 66"	CMPG6624P1	522	552	66	24	2 3/8
		CMPG6630P1	621	658	66	30	2 3/8
		CMPG6636P1	686	783	66	36	2 3/8
		CMPG6642P1	750	796	66	42	2 3/8
		CMPG6648P1	825	879	66	48	2 3/8
		CMPG6654P1	894	950	66	54	2 3/8
		CMPG6660P1	959	1021	66	60	2 3/8

**CMPGXXYP2 - POWERED COMPILE PARTLY GLAZED PREMIUM PANEL PACKAGE**

- With power distribution harness
- Includes one panel, power harness, and two raceway covers with punchouts.
- Individual fabric-covered modules incorporated into an aluminum frame.
- Opposite sides of each module may have a different fabric within the same grade at no upcharge.
- If different grades of fabric are used on one panel, the entire panel must be priced at highest grade.
- Panels are not tackable or acoustical.
- Trim is not required at a straight connection between two panels of the same height.
- 3 Panel connector brackets per side come standard with 54”h panels.
- 4 Panel connector brackets per side come standard with 66”h panels.
- Panels contain leveling glides. Maximum extension of glides is 2”.
- Standard clear (CLR) plexi.
- Optional Smoked Plexi-Glass or Frosted Plexi with 15% upcharge.
- PVC glass retainer in matching paint color.

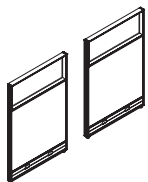
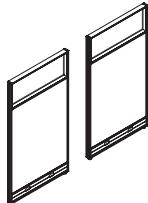
	DESCRIPTION	PRODUCT CODE	LIST PRICE		DIMENSIONS/INCHES		
			Gr1	Gr2	H	W	D
	Powered Compile Partly Glazed Premium Panel Package - 54"	CMPG5424P2	486	514	54	24	2 3/8
		CMPG5430P2	581	617	54	30	2 3/8
		CMPG5436P2	639	676	54	36	2 3/8
		CMPG5442P2	697	743	54	42	2 3/8
		CMPG5448P2	766	821	54	48	2 3/8
		CMPG5454P2	829	887	54	54	2 3/8
		CMPG5460P2	888	952	54	60	2 3/8
	Powered Compile Partly Glazed Premium Panel Package - 66"	CMPG6624P2	522	552	66	24	2 3/8
		CMPG6630P2	621	658	66	30	2 3/8
		CMPG6636P2	686	783	66	36	2 3/8
		CMPG6642P2	750	796	66	42	2 3/8
		CMPG6648P2	825	879	66	48	2 3/8
		CMPG6654P2	894	950	66	54	2 3/8
		CMPG6660P2	959	1021	66	60	2 3/8

**CMPSXX - COMPILE PRIVACY GLASS**

- Attaches on top of Compile Panels to add privacy or divide space.
- Standard in clear (CLR) or frosted (FRST) glass.
- Clamps available in satin chrome finish only.
- Width dimensions given are width of glass only.
- Attachment hardware is provided for attaching to panels.
- Please note Privacy Glass in 24” - 54” widths includes 2 clamps and a Privacy Glass in 60” width includes 3 clamps.
- Square profile on clamps and glass corners.

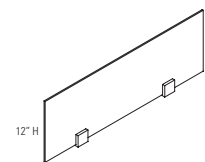
	DESCRIPTION	PRODUCT CODE	LIST PRICE		DIMENSIONS/INCHES		
			CLR	FRST	H	W	D
	Compile Privacy Glass	CMPS24	203	246	12	24	6mm
		CMPS30	214	248	12	30	6mm
		CMPS36	228	250	12	36	6mm
		CMPS42	234	274	12	42	6mm
		CMPS48	241	293	12	48	6mm
		CMPS54	249	311	12	54	6mm
		CMPS60	257	336	12	60	6mm



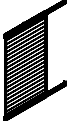

**CMPDSL/R - SLIDING PRIVACY DOOR**

- Sliding Privacy Door attaches to Compile Panels using standard connectors to add privacy. Brackets that attach to Connectors are included.
- This door must mount on panels of equal width. It is also intended to be used for openings of equal width.
- Left (L) or right-handedness (R) is determined by the direction of door movement (from compressed to expanded position), while facing the door on the panel mounted side.
- Painted frame may match any Compile Standard Paint Finish. The door interior is standard with a louvered acrylic finish.
- STL paint on Compile sliding doors is a smooth finish paint comparable to the standard STL paint offering.”
- Telescoping arms eliminate the need for thresholds, wheels or casters.
- Thickness of louvered acrylic is 6 mm.

	DESCRIPTION	PRODUCT CODE	LIST PRICE		DIMENSIONS/INCHES		
					H	W	D
	Sliding Privacy Door - 66" High	CMPDSL6636R	1980		66	36	
		CMPDSL6636L	1980		66	36	
		CMPDSL6642R	2031		66	42	
		CMPDSL6642L	2031		66	42	

**CMFOXXYYNO - NON-POWERED COMPILE SINGLE SEGMENTED OPEN BOTTOM PANEL PACKAGE**

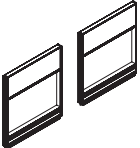
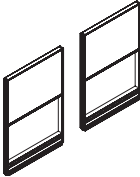
- Non powered.
- Includes one panel and two raceways covers with no punchouts and a integrated aluminum top cap.
- Individual fabric-covered module in upper position incorporated into an aluminum frame. Bottom is open.
- Opposite sides of each module may have a different fabric within the same grade at no upcharge.
- If different grades of fabric are used on one panel, the entire panel must be priced at highest grade.
- Panels are not tackable or acoustical.
- Trim is not required at a straight connection between two panels of the same height.
- 3 Panel connector brackets per side come standard with 42" h and 54" h panels.
- 4 Panel connector brackets per side come standard with 66" h panels.
- Panels contain leveling glides. Maximum extension of glides is 2" .

	DESCRIPTION	PRODUCT CODE	LIST PRICE		DIMENSIONS/INCHES		
			Gr1	Gr2	H	W	D
	Non-Powered Compile Single Segmented Open Bottom Panel Package - 42"	CMFO4224NO	244	253	42	24	2 3/8
		CMFO4230NO	274	282	42	30	2 3/8
		CMFO4236NO	290	307	42	36	2 3/8
		CMFO4242NO	332	349	42	42	2 3/8
		CMFO4248NO	353	370	42	48	2 3/8
		CMFO4254NO	394	415	42	54	2 3/8
		CMFO4260NO	421	438	42	60	2 3/8
	Non-Powered Compile Single Segmented Open Bottom Panel Package - 54"	CMFO5424NO	265	278	54	24	2 3/8
		CMFO5430NO	295	308	54	30	2 3/8
		CMFO5436NO	333	346	54	36	2 3/8
		CMFO5442NO	377	402	54	42	2 3/8
		CMFO5448NO	408	433	54	48	2 3/8
		CMFO5454NO	433	459	54	54	2 3/8
		CMFO5460NO	467	492	54	60	2 3/8
	Non-Powered Compile Single Segmented Open Bottom Panel Package - 66"	CMFO6624NO	310	331	66	24	2 3/8
		CMFO6630NO	355	376	66	30	2 3/8
		CMFO6636NO	395	432	66	36	2 3/8
		CMFO6642NO	450	488	66	42	2 3/8
		CMFO6648NO	477	515	66	48	2 3/8
		CMFO6654NO	518	555	66	54	2 3/8
		CMFO6660NO	550	587	66	60	2 3/8



**CMFOXXYYN1 - NON-POWERED COMPILE SINGLE SEGMENTED - OPEN BOTTOM PANEL PACKAGE**

- Non powered.
- Includes one panel, one raceway cover with no punchout, one raceway cover with punchout and a integrated aluminum top cap.
- Individual fabric-covered module in upper position incorporated into an aluminum frame. Bottom is open.
- Opposite sides of each module may have a different fabric within the same grade at no upcharge.
- If different grades of fabric are used on one panel, the entire panel must be priced at highest grade.
- Panels are not tackable or acoustical.
- Trim is not required at a straight connection between two panels of the same height.
- 3 Panel connector brackets per side come standard with 42”h and 54”h panels.
- 4 Panel connector brackets per side come standard with 66”h panels.
- Panels contain leveling glides. Maximum extension of glides is 2”.
- 24” wide panels have one punchout, 30” wide panels or wider have two punchouts.

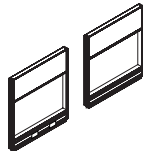
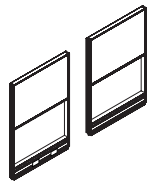
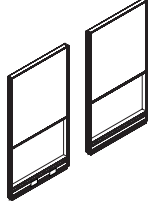
	DESCRIPTION	PRODUCT CODE	LIST PRICE		DIMENSIONS/INCHES		
			Gr1	Gr2	H	W	D
	Non-Powered Compile Single Segmented Open Bottom Panel Package - 42"	CMFO4224N1	244	253	42	24	2 3/8
		CMFO4230N1	274	282	42	30	2 3/8
		CMFO4236N1	290	307	42	36	2 3/8
		CMFO4242N1	332	349	42	42	2 3/8
		CMFO4248N1	353	370	42	48	2 3/8
		CMFO4254N1	394	402	42	54	2 3/8
	Non-Powered Compile Single Segmented Open Bottom Panel Package - 54"	CMFO5424N1	265	278	54	24	2 3/8
		CMFO5430N1	295	308	54	30	2 3/8
		CMFO5436N1	333	346	54	36	2 3/8
		CMFO5442N1	377	402	54	42	2 3/8
		CMFO5448N1	408	433	54	48	2 3/8
		CMFO5454N1	433	459	54	54	2 3/8
	Non-Powered Compile Single Segmented Open Bottom Panel Package - 66"	CMFO6624N1	310	331	66	24	2 3/8
		CMFO6630N1	355	376	6	30	2 3/8
		CMFO6636N1	395	432	66	36	2 3/8
		CMFO6642N1	450	488	66	42	2 3/8
		CMFO6648N1	477	515	66	48	2 3/8
		CMFO6654N1	518	555	66	54	2 3/8
CMFO6660N1	550	587	66	60	2 3/8		



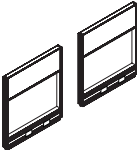
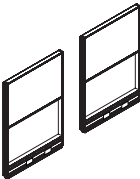
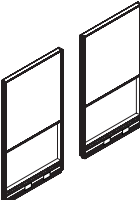

**CMFOXXYYN2 - NON-POWERED COMPILE SINGLE SEGMENTED - OPEN BOTTOM PANEL PACKAGE**

- Non powered.
- Includes one panel, two raceway covers with punchouts and a integrated aluminum top cap.
- Individual fabric-covered module in upper position incorporated into an aluminum frame. Bottom is open.
- Opposite sides of each module may have a different fabric within the same grade at no upcharge.
- If different grades of fabric are used on one panel, the entire panel must be priced at highest grade.
- Panels are not tackable or acoustical.
- Trim is not required at a straight connection between two panels of the same height.
- 3 Panel connector brackets per side come standard with 42" h and 54" h panels.
- 4 Panel connector brackets per side come standard with 66" h panels.
- Panels contain leveling glides. Maximum extension of glides is 2".
- 24" wide panels have one punchout, 30" wide panels or wider have two punchouts.

	DESCRIPTION	PRODUCT CODE	LIST PRICE		DIMENSIONS/INCHES		
			Gr1	Gr2	H	W	D
	Non-Powered Compile Single Segmented Open Bottom Panel Package - 42"	CMFO4224N2	244	253	42	24	2 3/8
		CMFO4230N2	274	282	42	30	2 3/8
		CMFO4236N2	290	307	42	36	2 3/8
		CMFO4242N2	332	332	42	42	2 3/8
		CMFO4248N2	353	370	42	48	2 3/8
		CMFO4254N2	394	402	42	54	2 3/8
		CMFO4260N2	421	438	42	60	2 3/8
	Non-Powered Compile Single Segmented Open Bottom Panel Package - 54"	CMFO5424N2	265	278	54	24	2 3/8
		CMFO5430N2	295	308	54	30	2 3/8
		CMFO5436N2	333	346	54	36	2 3/8
		CMFO5442N2	377	428	54	42	2 3/8
		CMFO5448N2	408	433	54	48	2 3/8
		CMFO5454N2	433	459	54	54	2 3/8
		CMFO5460N2	467	492	54	60	2 3/8
	Non-Powered Compile Single Segmented Open Bottom Panel Package - 66"	CMFO6624N2	310	331	66	24	2 3/8
		CMFO6630N2	355	376	6	30	2 3/8
		CMFO6636N2	395	432	66	36	2 3/8
		CMFO6642N2	450	488	66	42	2 3/8
		CMFO6648N2	477	515	66	48	2 3/8
		CMFO6654N2	518	555	66	54	2 3/8
		CMFO6660N2	550	587	66	60	2 3/8

**CMFOXYYP1 - POWERED COMPILE SINGLE SEGMENTED - OPEN BOTTOM PANEL PACKAGE**

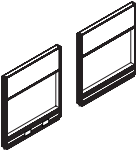
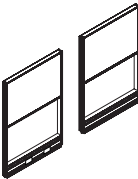
- With power distribution harness.
- Includes one panel, power harness, one raceway cover with punchout, one raceway cover without punchout and a integrated aluminum top cap.
- Individual fabric-covered module in upper position incorporated into an aluminum frame. Bottom is open.
- Opposite sides of each module may have a different fabric within the same grade at no upcharge.
- If different grades of fabric are used on one panel, the entire panel must be priced at highest grade.
- Panels are not tackable or acoustical.
- Trim is not required at a straight connection between two panels of the same height.
- 3 Panel connector brackets per side come standard with 42”h and 54”h panels.
- 4 Panel connector brackets per side come standard with 66”h panels.
- Panels contain leveling glides. Maximum extension of glides is 2”.
- 24” wide panels have one punchout, 30” wide panels or wider have two punchouts.

	DESCRIPTION	PRODUCT CODE	LIST PRICE		DIMENSIONS/INCHES		
			Gr1	Gr2	H	W	D
	Powered Compile Single Segmented Open Bottom Panel Package - 42”	CMFO4224P1	341	350	42	24	2 3/8
		CMFO4230P1	406	415	42	30	2 3/8
		CMFO4236P1	428	445	42	36	2 3/8
		CMFO4242P1	472	489	42	42	2 3/8
		CMFO4248P1	505	522	42	48	2 3/8
		CMFO4254P1	547	555	42	54	2 3/8
		CMFO4260P1	575	592	42	60	2 3/8
	Powered Compile Single Segmented Open Bottom Panel Package - 54”	CMFO5424P1	363	376	54	24	2 3/8
		CMFO5430P1	427	439	54	30	2 3/8
		CMFO5436P1	471	484	54	36	2 3/8
		CMFO5442P1	518	544	54	42	2 3/8
		CMFO5448P1	560	586	54	48	2 3/8
		CMFO5454P1	587	612	54	54	2 3/8
		CMFO5460P1	620	645	54	60	2 3/8
	Powered Compile Single Segmented Open Bottom Panel Package - 66”	CMFO6624P1	409	429	66	24	2 3/8
		CMFO6630P1	486	507	6	30	2 3/8
		CMFO6636P1	533	571	66	36	2 3/8
		CMFO6642P1	591	628	66	42	2 3/8
		CMFO6648P1	628	666	66	48	2 3/8
		CMFO6654P1	670	707	66	54	2 3/8
		CMFO6660P1	704	742	66	60	2 3/8



**CMFOXXYP2 - POWERED COMPILE SINGLE SEGMENTED - OPEN BOTTOM PANEL PACKAGE**

- With power distribution harness.
- Includes one panel, power harness, two raceway covers with punchout and a integrated aluminum top cap.
- Individual fabric-covered module in upper position incorporated into an aluminum frame. Bottom is open.
- Opposite sides of each module may have a different fabric within the same grade at no upcharge.
- If different grades of fabric are used on one panel, the entire panel must be priced at highest grade.
- Panels are not tackable or acoustical.
- Trim is not required at a straight connection between two panels of the same height.
- 3 Panel connector brackets per side come standard with 42”h and 54”h panels.
- 4 Panel connector brackets per side come standard with 66”h panels.
- Panels contain leveling glides. Maximum extension of glides is 2”.
- 24” wide panels have one punchout, 30” wide panels or wider have two punchouts.

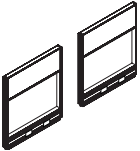
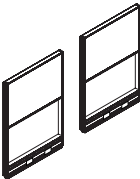
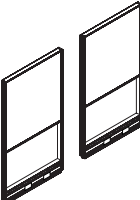
	DESCRIPTION	PRODUCT CODE	LIST PRICE		DIMENSIONS/INCHES		
			Gr1	Gr2	H	W	D
	Powered Compile Single Segmented Open Bottom Panel Package - 42”	CMFO4224P2	341	350	42	24	2 3/8
		CMFO4230P2	406	415	42	30	2 3/8
		CMFO4236P2	428	445	42	36	2 3/8
		CMFO4242P2	472	489	42	42	2 3/8
		CMFO4248P2	505	522	42	48	2 3/8
		CMFO4254P2	547	555	42	54	2 3/8
	Powered Compile Single Segmented Open Bottom Panel Package - 54”	CMFO5424P2	363	376	54	24	2 3/8
		CMFO5430P2	427	439	54	30	2 3/8
		CMFO5436P2	471	484	54	36	2 3/8
		CMFO5442P2	518	544	54	42	2 3/8
		CMFO5448P2	560	586	54	48	2 3/8
		CMFO5454P2	587	612	54	54	2 3/8
	Powered Compile Single Segmented Open Bottom Panel Package - 66”	CMFO6624P2	409	429	66	24	2 3/8
		CMFO6630P2	486	507	66	30	2 3/8
		CMFO6636P2	533	571	66	36	2 3/8
		CMFO6642P2	591	628	66	42	2 3/8
		CMFO6648P2	628	666	66	48	2 3/8
		CMFO6654P2	670	707	66	54	2 3/8
		CMFO6660P2	704	742	66	60	2 3/8



**CMFMA - MINI PANEL KIT**

- Compile’s Mini Panel Kits are now available to our dealers and their sales staff. The Compile mini panel is an excellent sales tool featuring two panel and samples of various hardware and electrical components and consists of the following:
  - One Monolithic Mini Panel (Laminate side one / Acoustic side two).
  - One Segmented Glazed Mini panel.
  - One 2-way Universal Corner Post Kit.
  - Two 24” Raceway Cover with Punch Out.
  - Two 24” Raceway Cover with out Punch Out.
  - One Raceway Cut Out Cover.
  - One 3-way Post Base Cover.
  - One End of Run Trim.
  - One Pair of Corner Brackets.
  - One Mid span Worksurface Support Bracket.
  - One Duplex.
  - One Power Distribution Harness.
  - One Mesh jumper.
  - One Carry Bag.

	DESCRIPTION	PRODUCT CODE	LIST PRICE	DIMENSIONS/INCHES		
				H	W	D
	Mini Panel Kit	CMFMA2418KIT1	1685	30	24	2 7/8



**CHP POST PACKAGE**

- Universal Post with all "Quick-Connection" clips.
- Post trim(s)
- Post base and top cap

	DESCRIPTION	PRODUCT CODE	LIST PRICE	DIMENSIONS/INCHES		
				H	W	D
	2 - Way Post	CHP30-2	78	30		
		CHP42-2	78	42		
		CHP54-2	96	54		
		CHP66-2	114	66		
	3 - Way Post	CHP30-3	68	30		
		CHP42-3	68	42		
		CHP54-3	86	54		
		CHP66-3	103	66		
	4 - Way Post *No trim or base. Includes top cap only.	CHP30-4	54	30		
		CHP42-4	54	42		
		CHP54-4	70	54		
		CHP66-4	86	66		

**CHPXW - 60 DEGREE POST PACKAGE**

- Universal Post with all "Quick-Connection" clips.
- Post trim is incorporated into 2 - Way aluminum post extrusion.
- Post top cap
- Outer part of the post is the full panel height and the inner part of the post is 6" shorter.
- 3 - Way post is 6" shorter than panel height to accommodate electric and base.
- PVC post trims can not be added to 60 degree posts.

	DESCRIPTION	PRODUCT CODE	LIST PRICE	DIMENSIONS/INCHES		
				H	W	D
	2 - Way - 60 Degree Post Package	CHP2W30	54	30		
		CHP2W42	54	42		
		CHP2W54	70	54		
		CHP2W66	86	66		
	3 - Way - 60 Degree Post Package	CHP3W30	54	30		
		CHP3W42	54	42		
		CHP3W54	70	54		
		CHP3W66	86	66		

**CMRCXXNP - COMPILE RACEWAY COVER - WITHOUT KNOCKOUTS**

- No electrical knockouts included.
- Note: Made of reinforced aluminum.

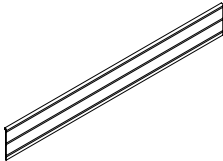
	DESCRIPTION	PRODUCT CODE	LIST PRICE	DIMENSIONS/INCHES		
				H	W	D
	Compile Raceway Cover Without Knockouts	CMRC24NP	10		24	
		CMRC30NP	13		30	
		CMRC36NP	15		36	
		CMRC42NP	17		42	
		CMRC48NP	19		48	
		CMRC54NP	24		54	
		CMRC60NP	26		60	

**CMRCXXPO - COMPILE RACEWAY COVER - WITH KNOCKOUTS**

- Contains one knockout for 24" w and two knockouts for 30" w+.
- Raceway Knockout Cover must be added to openings where duplex receptacles are not used.
- Note: Made of reinforced aluminum.

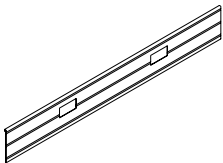
	DESCRIPTION	PRODUCT CODE	LIST PRICE	DIMENSIONS/INCHES		
				H	W	D
	Compile Raceway Cover With Knockouts	CMRC24PO	10		24	
		CMRC30PO	13		30	
		CMRC36PO	15		36	
		CMRC42PO	17		42	
		CMRC48PO	19		48	
		CMRC54PO	24		54	
		CMRC60PO	26		60	

**CMRCB01 - COMPILE RACEWAY KNOCKOUT COVER**

- Fills knockout when duplex is not used.
- Available in Black, White, Nevada, and Tungsten (Steel)
- Note: Knockout covers are made of plastic.

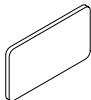
	DESCRIPTION	PRODUCT CODE	LIST PRICE	DIMENSIONS/INCHES		
				H	W	D
	Compile Raceway Knockout Cover	CMRCB01	9			



**CHP - 90-DEGREE UNIVERSAL CORNER POST**

- Available in 42", 54" and 66"h.
- Standard Compile paint options.
- Specify the corner post height that matches the tallest or smallest panel connection.
- Can be used for any variation of 90-degree connections: 2-way, 3-way or 4-way.
- Requires post trim inserts to finish off post where there are no panel connections. Post trim inserts are specified separately.
- 6" shorter than panel height to accommodate electric in base.
- Requires a post basecover to finish off post at the base (for 2- or 3-way). Refer to CMPC.
- See Panel Configuration Tips for application.
- Made of aluminum.

DESCRIPTION	PRODUCT CODE	LIST PRICE	DIMENSIONS/INCHES		
			H	W	D
 90-Degree Universal Corner Post	CHP30	54	30		
	CHP42	54	36		
	CHP54	70	48		
	CHP66	86	60		

**CMET - END OF RUN TRIM INSERT FOR PANEL**

- Trim inserts are not included with panels.
- Cannot be used for a universal post application.
- Used at the end of each panel run and cannot be used to attach a panel run to a fixed wall.
- Vertical trims must be specified separately. Trim snaps in the panel at the end of run.
- Standard Compile paint options.
- See Panel Configuration Tips for application.
- Trims are PVC.

DESCRIPTION	PRODUCT CODE	LIST PRICE	DIMENSIONS/INCHES		
			H	W	D
 End of Run Trim Insert for Panel	CMET30	9	30		
	CMET42	9	42		
	CMET54	10	54		
	CMET66	11	66		



**CMETP - TRIM INSERT FOR UNIVERSAL CORNER POST**

- Does not come with a post.
- Trim installs on all exposed sides of a Universal Corner Post.
- Specify to equal post height.
- Trims must be specified separately. Trim snaps in the post.
- Available in standard Compile paint options.
- 6" shorter than Universal Corner Post to accommodate Post Base Cover (must be specified separate)
- See Panel Configuration Tips for application.

DESCRIPTION	PRODUCT CODE	LIST PRICE	DIMENSIONS/INCHES		
			H	W	D
 Trim Insert for Universal Corner Post	CMETP30	9	30		
	CMETP42	9	36		
	CMETP54	10	48		
	CMETP66	11	60		

**CMET - TRIM INSERT FOR STEP DOWN**

- Does not come with a post. Trim inserts are not included with Universal Corner Posts.
- Specify to meet the taller post.
- Trim snaps in the post or end of run at a change in height.
- Available in standard Compile paint options.
- Can not be applied to 60 degree posts.
- See Panel Configuration Tips for application.

DESCRIPTION	PRODUCT CODE	LIST PRICE	DIMENSIONS/INCHES		
			H	W	D
 Trim Insert for Step Down	CMET12	3	12		
	CMET24	6	24		
	CMET36		36		

**CHWAXX - WALL ADAPTER**

- Same profile as vertical extrusion.
- Wall attachment hardware not provided.
- Made of aluminum.

DESCRIPTION	PRODUCT CODE	LIST PRICE	DIMENSIONS/INCHES		
			H	W	D
 Wall Adapter	CHWA30	27	30		
	CHWA42	27	42		
	CHWA54	32	54		
	CHWA66	39	66		



**CWMA - VERTICAL CHANNEL**

- Used to attach system components to fixed wall.
- Panel frame finish.
- Comes in 60" length only.
- Care should be taken to mount adapters only to wall studs using correct fasteners.
- Does not include mounting hardware. Mounting hardware selection to be based on wall material. Sold in pairs.
- Failure to do this may result in collapse of the unit and subsequent possible personal injury.
- Compile vertical channels cannot be shared.

	DESCRIPTION	PRODUCT CODE	LIST PRICE	DIMENSIONS/INCHES		
				H	W	D
	Vertical Channel	CWMA60	26	60	0.6	0.7

**CMPC - UNIVERSAL POST CAP**

- Comes standard with universal post.
- Specified separately for reconfiguration purposes.
- Available in standard Compile paint options.
- Made of PVC.

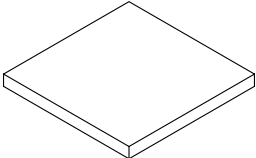
	DESCRIPTION	PRODUCT CODE	LIST PRICE	DIMENSIONS/INCHES		
				H	W	D
	Universal Post Cap	CMPC	2	2 3/8		

**CMPC - POST BASE COVER**

- Post Base Covers are not included with Universal Corner Posts.
- Base trim for universal post. These are connected with screws at the base and the trims at the post will slide to meet.
- Available for 2-way and 3-way configurations.
- Finish is smooth plastic.
- Available in standard Compile paint options.

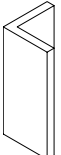
	DESCRIPTION	PRODUCT CODE	LIST PRICE	DIMENSIONS/INCHES		
				H	W	D
	Post Base Cover - 3-Way Connection	CMPC1	6	6		
	Post Base Cover - 2-Way Connection	CMPC2	7	6		

**CMPS - POST SEPARATOR**

- Creates a diagonal division within a compile post.
- Please specify post height.

	DESCRIPTION	PRODUCT CODE	LIST PRICE	DIMENSIONS/INCHES		
				H	W	D
	Post Separator	CMPS01	106	96	3.25	14

electrical

**STEP-BY-STEP SPECIFICATION – 8-WIRE ELECTRICAL SYSTEM**

**Step 1 Determine the location of the source power entering the Panel Run.**

1. At the base of the Panel.
  - (a) Use CE8FR1 Reversible Floor Power Entry (default to CE8FR1).
  - (b) Select the Panel to which the Floor Power Entry will be attached.
  - (c) Select the side of the Panel and the receptacle outlet to which the Floor Power Entry is to be attached.

Note: When using Pass Through Connectors in conditions other than a straight line, you must use a CE8CI-1 I-Connector along with a CE8CP17 Flexible Mesh Jumper Cable through the corner post.

**Step 2 Determine which Panels are to be powered.**

1. Use CE8PD Power Distribution Housing that corresponds with the width of the Panel.

**Step 3 Connect power to the powered Panels.**

1. Use CE8CP17 Flexible Mesh Jumper Cable between two adjacent powered Panels.
2. Use CE8CP17 Flexible Mesh Jumper Cable between two adjacent powered Panels separated by a post.
3. Use CE8CP17 Flexible Mesh cable (to turn the post) and a CE8CI-1 "I" Connector to attach the CE8CP Pass Through Cable.
  - (a) The length of the Pass-Through Cable is calculated by adding together the widths of the non-powered Panels that separate the two powered Panels and applying an additional 16" to the total. (CE8PD Power Distribution Housing is positioned 8" in from the ends of the powered Panel.)
  - (b) An additional 3" must be added to the Pass-Through Cable for each post that the cable passes through.
  - (c) Subtract 17" from the total length to find the pass through cable length required.
4. From the price list, select the CE8CP Pass-Through Cable that matches the calculated length. If the length is between listed sizes, use the next size up.

**Step 4 Determine the location and circuitry of the receptacles.**

1. Each powered Panel has four (4) potential locations for CE8RD Duplex Receptacles – 2 per side. (Exception: 24" wide Panel has only two potential locations – 1 per side.)
2. At each receptacle location there is a choice of four circuit options. Select a circuit option for each location. Circuits one & two are utility circuits; circuits A & B are dedicated circuits.

**COMPILE'S 8-WIRE ELECTRICAL SYSTEM**

**Electrical**

This modification allows for the integration of the commonly required "2+2" configuration (2 utility circuits, 2 dedicated circuits) found in the source power of most of today's North American buildings.

**This system is rated for connection to:**

1. A grounded 120/240V, single phase, 20 A, 60Hz
2. A 120/208V, 3 phase, 20 A, 60Hz branch circuit

**EQUIPMENT AMPERAGE**

Calculator .....	0.25
Electric Eraser .....	0.50
Pencil Sharpener.....	1.00
Radio .....	0.05
Paper Shredder.....	4.40 - 13.00
Electric Typewriter .....	1.20
Personal Computer .....	2.00 - 4.00
Video Display Terminal .....	0.08
Draft / Letter Quality Printer .....	1.20 - 3.00
Laser Printer.....	5.00 - 8.00
Processor / Disk Unit.....	1.00 - 10.00

**Data/Comm**

Compile's duplex receptacle openings (1.345 x 2.80) will conform to the ANSI/TIA/EIA Furniture Opening Standard of 1.38 +/- .035 x 2.71 +/- .04

Desk Top Plotter .....	1.50
Fan .....	1.00
Heater .....	8.50 - 12.50
Coffee Pot.....	15.00
Task Light .....	1.00
Slide Projector .....	2.00 - 6.00

Since some equipment, such as large copiers, printers, plotters, heaters and coffee makers would occupy most of the circuit capacity, it is recommended that such devices be supplied with the power directly from the wall or building receptacle.



Wiring Schematic

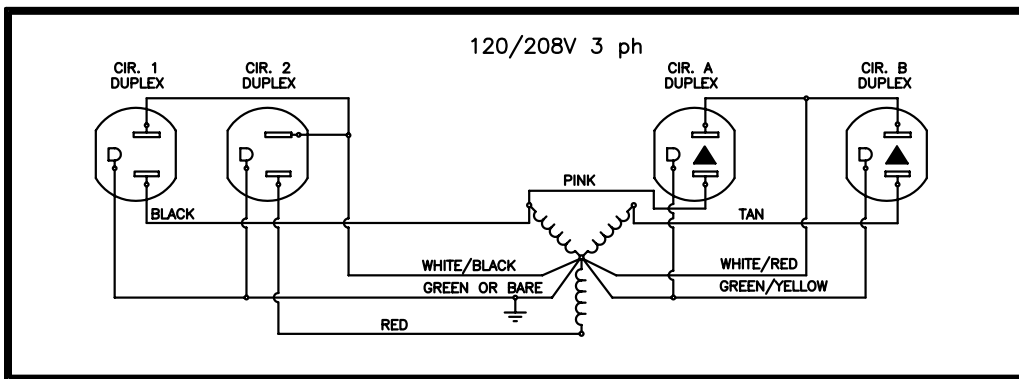
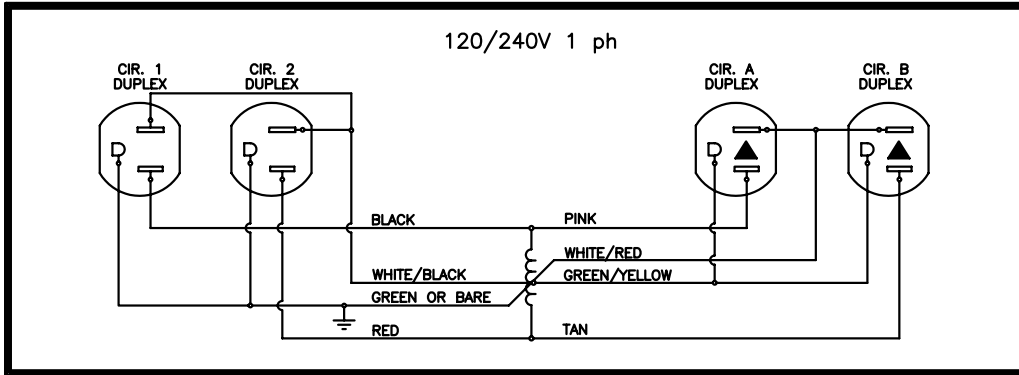

Defining "2 + 2" Wiring Configurations

**2 + 2 Configuration (8 wire, 4 circuit)**

Two Utility Circuits [Compile's new #1 & #2 circuits] share one neutral wire and one ground wire.  
 (2 hot [circuit] wires + 1 neutral wire\*\*\* + 1 green ground wire\* = 4 wires)

Two Dedicated Circuits [Compile's new "A" & "B" circuits] share one neutral wire and one ground wire.  
 (2 hot [circuit] wires + 1 neutral wire\*\*\* + 1 green/yellow ground wire\*\* = 4 wires)

Note:

It is the ground wire that makes the difference between "Utility" and "Dedicated" circuits. Refer to Wiring Schematics found above.

\* A Green ground wire is a "system" ground. This means it could be grounded to any piece of metal, including the Panel.

\*\* A Green/Yellow ground wire is isolated, within the wiring conduit, all the way back to the box at the source (building ground).

\*\*\* All Neutral Wires are 10 gauge rather than 12 gauge meaning they are larger than normal, allowing greater protection against "noise" or interference on the circuit.

This page provides an exploded view of a sample configuration highlighting each **Electrical** component required when specifying this configuration.

**Components**

- A. CE8PD36 Power Distribution Housing  
Note: 8 wire, 4 circuits, 2+2 configuration
- B. CE8CP17 Flexible Mesh Jumper Cable (connects two panels side by side or separated by a post)
- C. CE8RD Duplex Receptacle
- D. CE8CI-1 "I" Connector
- E. CE8CP Pass-Through Cable  
Note: Must run in a straight line application only  
Note: Pass-Through Extension Cable (CE8CPF154) available – extends power capability beyond 208".

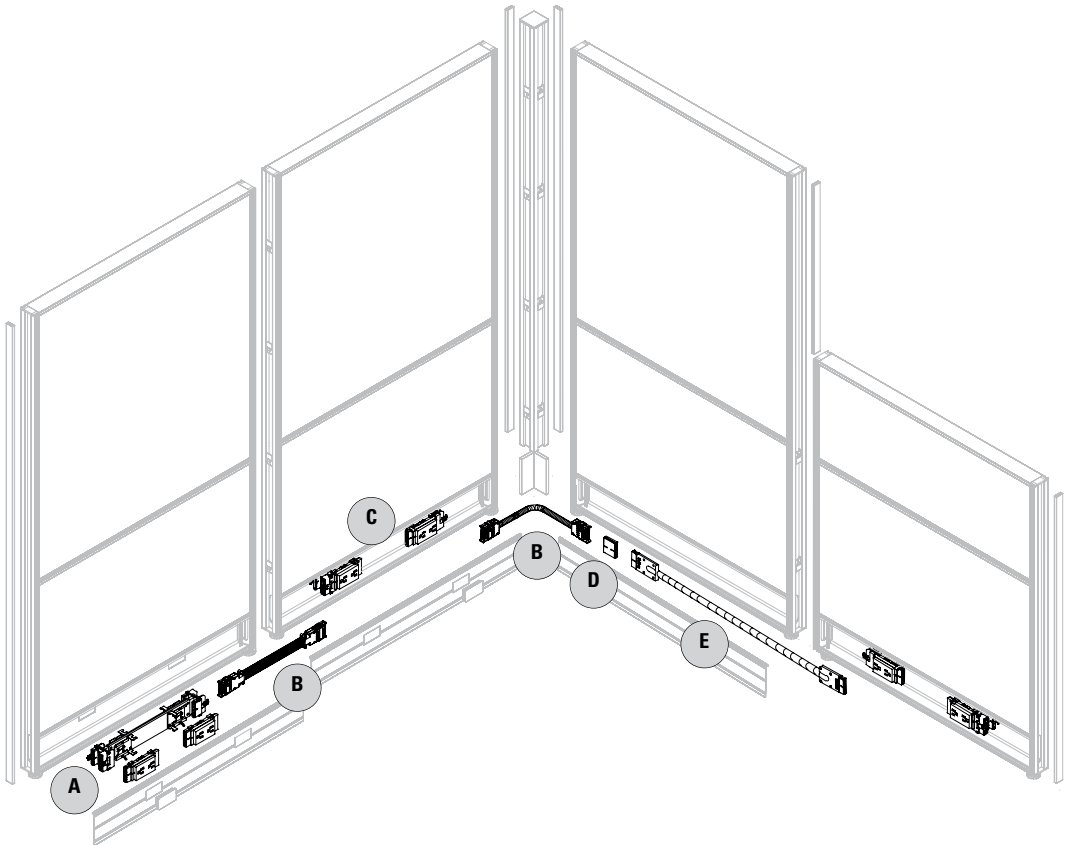

# ELECTRICAL

## E8PD - POWER DISTRIBUTION HOUSING

- Power housing is specified per panel size (e.g. CE8PD36 is for use in a 36" panel).
- 8 wire, 4 circuits (4th circuit dedicated).
- Power distribution housing is required for each powered panel, the power distribution housing should equal the width of the panel that it is specified in.
- Provides two duplex receptacle ports per panel side on all panel widths except the 24" wide panel.
- 24" wide panel allows for only one (1) duplex receptacle on one panel side.
- Each power distribution housing supports 15-20 amps.
- Must specify Raceway Cover with Knockouts on panels, where Power Distribution Housings will be utilized.

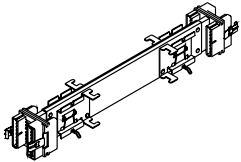
	DESCRIPTION	PRODUCT CODE	LIST PRICE	DIMENSIONS/INCHES		
				H	W	D
	Power Distribution Housing	CE8PD24	106	6 1/4		
		CE8PD30	143	11 1/2		
		CE8PD36	150	17 1/2		
		CE8PD42	153	23 1/2		
		CE8PD48	165	29 1/2		
		CE8PD54	166	39 1/4		
		CE8PD60	167	41 1/2		

## CE8CP17 - FLEXIBLE MESH JUMPER CABLE

- 17" mesh jumper.
- Jumper cable is used to pass through a post or connect two panels together.

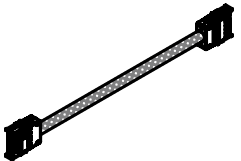
	DESCRIPTION	PRODUCT CODE	LIST PRICE	DIMENSIONS/INCHES		
				H	W	D
	Flexible Mesh Jumper Cable	CE8CP17	81	17		



# ELECTRICAL

## CE8CP - PASS THROUGH CABLE

- Flexible metal conduit is used to distribute electrical power through non-powered panels.
- Metal conduit pass through cables should be in used in a straight runs. Metal conduit pass through cables cannot pass through a post.
- Flexible conduit is required to turn a post. This only comes as 17" w. If panels at the posts do not all have power distribution housings, they must be added even if duplexes are not specified.
- To calculate the length of a Pass-Through Cable, add the widths of the non-powered panels separating the powered panels (panels with distribution housing attached). To this add 16" (distance from the edge of the panel to the distribution housing x 2).
- Add additional 3" when passing through a corner post. See the Tips at the beginning of the section for more details.

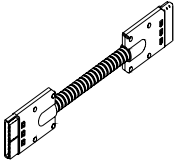
DESCRIPTION	PRODUCT CODE	LIST PRICE	DIMENSIONS/INCHES		
			H	W	D
 Pass Through Cable	CE8CP28	108	28	1/2	
	CE8CP40	114	40	1/2	
	CE8CP46	117	46	1/2	
	CE8CP52	121	52	1/2	
	CE8CP58	128	58	1/2	
	CE8CP64	134	64	1/2	
	CE8CP70	138	70	1/2	
	CE8CP76	140	76	1/2	
	CE8CP82	146	82	1/2	
	CE8CP88	150	88	1/2	
	CE8CP94	154	94	1/2	
	CE8CP100	159	100	1/2	
	CE8CP106	167	106	1/2	
	CE8CP118	175	118	1/2	
	CE8CP130	192	130	1/2	
	CE8CP142	201	142	1/2	
	CE8CP154	211	154	1/2	
	CE8CP172	226	172	1/2	
	CE8CP190	238	190	1/2	
	CE8CP208	246	208	1/2	
Pass Through Extension Cable	CE8CPF154	211	154	1/2	

## CE8CI-1 - "I" CONNECTOR

- Female - Female connector connects two Pass-Through Cables.
- Connects 17" Flexible Jumper Cable or ceiling feeds to pass through cables.

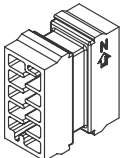
DESCRIPTION	PRODUCT CODE	LIST PRICE	DIMENSIONS/INCHES		
			H	W	D
 "I" Connector	CE8CI-1	60			



# ELECTRICAL

## CE8RD - DUPLEX RECEPTACLE

- Up to 3 receptacles per circuit
- Up to 6 receptacles per circuit (24 per infeed), not to exceed total of 15 Amps per circuit.
- Duplex Receptacles standard in Black (BLK).

- CE8RD1 = Circuit #1 (utility circuit)
- CE8RD2 = Circuit #2 (utility circuit)
- CE8RDA = Circuit A (dedicated)
- CE8RDB = Circuit B (dedicated)
- CE8RD1 and CE8RD2 (#1 and #2 share common ground)
- CE8RDA and CE8RDB (A and B share common ground)

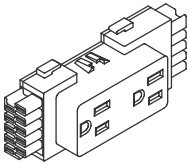
	DESCRIPTION	PRODUCT CODE	LIST PRICE	DIMENSIONS/INCHES		
				H	W	D
	Duplex Receptacle	CE8RD1	22			
		CE8RD2	22			
		CE8RDA	22			
		CE8RDB	22			

## CE8FR1 - REVERSIBLE FLOOR POWER ENTRY

- Takes the place of a duplex receptacle by snapping into the base power way.
- Includes 72" long flexible metal conduit.
- Must be hard wired to source power by a licensed electrician.
- Diameter is 0.85"

## CE8FR2 - REVERSIBLE FLOOR POWER ENTRY

- Takes the place of a duplex receptacle by snapping into the base power way.
- Includes 144" long flexible metal conduit.
- Must be hard wired to source power by a licensed electrician.

	DESCRIPTION	PRODUCT CODE	LIST PRICE	DIMENSIONS/INCHES		
				H	W	D
	Reversible Floor Power Entry	CE8FR1	239		72	
	Reversible Floor Power Entry	CE8FR2	309		144	

## CMEB01 - ELECTRICAL BOX - CHICAGO

- Can be retrofitted in any size of panel at the receptacle location.
- Gives access from one side only at each location.
- Customer to supply conduit, wiring, receptacle, and face plate.

- 2 per panel ,except 24" panel only one
- Note: A licensed electrician must provide hardware connection with the junction box.

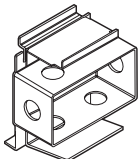
	DESCRIPTION	PRODUCT CODE	LIST PRICE	DIMENSIONS/INCHES		
				H	W	D
	Electrical Box - Chicago	CMEB01	68			

# ELECTRICAL

## CMEB02NY - ELECTRICAL BOX - NEW YORK

- Shipped assembled.
- Comes with pig tail electric.
- Use with 30" wide Panel of larger
- Post extension cable capacities: without electric, 30 with electric, 20
- Includes ceiling bezel and screws.

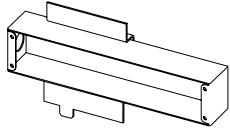
	DESCRIPTION	PRODUCT CODE	LIST PRICE	DIMENSIONS/INCHES		
				H	W	D
	Electrical Box - New York	CMEB02NY	306			

## CEPEXX - POST EXTENSION

- Same profile as post.
- Includes two post extension brackets, four screws and four trim inserts.
- Includes ceiling bezel and screws.

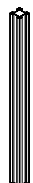
	DESCRIPTION	PRODUCT CODE	LIST PRICE	DIMENSIONS/INCHES		
				H	W	D
	Post Extension	CEPE64	131	64		
		CEPE82	173	82		

## CE8ECX - CEILING FEED

- Snaps into the end of a Power Distribution Housing.
- Flexible metal conduit extends into the ceiling through a corner post and post extension.
- Must be hard wired to source power by a licensed electrician.
- 4" junction box included.
- Post extension ordered separately

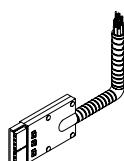
	DESCRIPTION	PRODUCT CODE	LIST PRICE	DIMENSIONS/INCHES		
				H	W	D
	Ceiling Feed	CE8EC1	184	132		
		CE8EC2	323	144		
		CE8EC3	365	180		



# ELECTRICAL

## CEET - UNDER STORAGE LOW WATTAGE (T5) TASK LIGHTS

- Task light must be at least 6" shorter than storage component to which it is attached.
- T5 rapid start fluorescent lamps
- Uses low wattage for energy efficient illumination
- Meets Chicago and NY electrical codes
- Electronic ballast
- Miniature rocker switch, positive position rocker
- 7 ft. black cord on all under storage models except 48". 48" models come with a 9 ft. cord.
- Available in black only
- Task light bulbs not replaced by manufacturer.

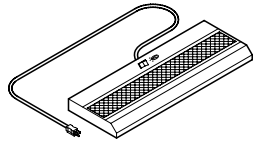

DESCRIPTION	PRODUCT CODE	LIST PRICE	DIMENSIONS/INCHES		
			H	W	D
Under Storage Low Wattage (T5) Task Lights	CEET5L18	136		18	
	CEET5L24	143		24	
	CEET5L36	153		36	
	CEET5L48	171		48	

## CMECC - CABLE COVER

- Attaches to panels vertically between modules to provide enclosures for power or data cords.
- Available in Steel (STL), Black (BLK), Nevada (NEV) only.
- Available in 21" and 36" lengths, 6 per pack.



DESCRIPTION	PRODUCT CODE	LIST PRICE	DIMENSIONS/INCHES		
			H	W	D
Cord Cover	CMECC21	21	21	0.5	1
	CMECC36	32	36	0.5	1



worksurfaces

**The information listed below provides you with basic features of Compile Worksurfaces.**

- Compile thermally fused Worksurfaces are 1" thick and are finished with 3 mm PVC edging on all sides.
- Worksurfaces are predrilled to enable proper alignment with worksurface supports.
- Standard laminate offerings are available in thermally-fused (T). See laminate listings for details.
- Wood grain laminates on corner Worksurfaces up to 42" available in laminate run diagonally for an upcharge. Otherwise, standard horizontal application of laminate will be used.
- Most wood grain laminate Worksurfaces will have matching woodgrain trim unless specified otherwise.
- Depth of the Worksurface scoops are 1 1/8" when measured from the Panel the Worksurface is attached to.
- All Worksurfaces require support items. These are priced separately within this section.
- Grain Direction for Worksurfaces are as follows:

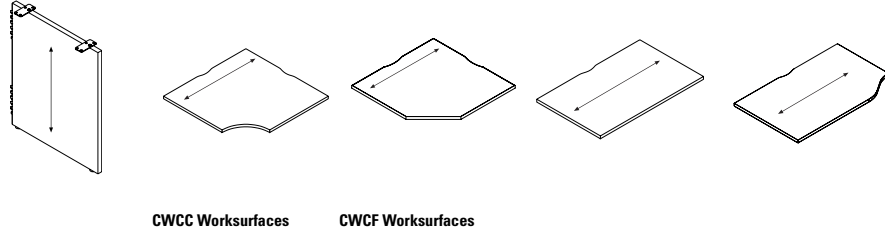

- Communication and electrical wires are routed through a cable scoop located at the back of the Worksurface. When specifying a Straight Worksurface (CWS) or a Curvilinear Worksurface (CWVL), note that the number of cable scoops depends upon the width of the Worksurface. All other Worksurface shapes have one scoop on Panel edges.

**One Scoop  
CWS 24" – 48"**

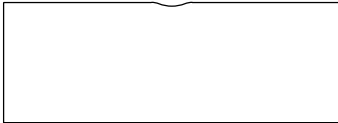

**Two Scoops  
CWS 54" – 84"**



**One Scoop  
CWVL 24" – 48"**



**Two Scoops  
CWVL 54" – 84"**



This page provides a three dimensional view of a sample configuration highlighting each **Worksurface** component required when specifying this configuration.

## Components

- A.** CWVL2436 Curvilinear Worksurface – Left  
Note: When deepest end equals 24", opposite depth is 18"  
When deepest end equals 30", opposite depth is 24"
- B.** CWCC3618 Corner Curved Worksurface
- C.** CWVR2436 Curvilinear Worksurface – Right

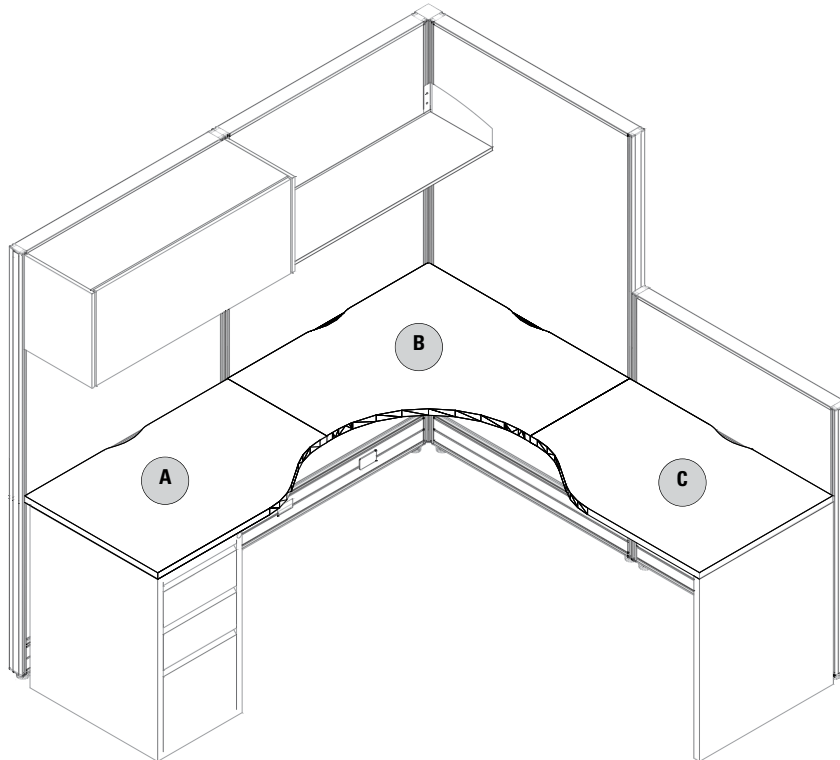



# WORKSURFACES

## CWS - RECTANGULAR WORKSURFACES

- All tops are thermally fused 1" thick with pilot holes to enable proper alignment with worksurface supports. Wood screws must be used.
- Compile worksurfaces feature a 3mm edge.
- Support hardware must be ordered separately. See the listings in this section.
- Width and depth dimensions listed include a nominal measurement (3/8") to account for wire management between the worksurface and adjoining panel.
- All surfaces over 48" will have two scoops, all others have one.

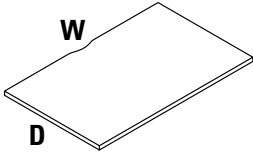
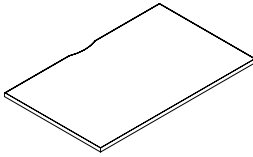
	DESCRIPTION	PRODUCT CODE	LIST PRICE	DIMENSIONS/INCHES	
				D	W
	Rectangular Worksurfaces - 24" Deep	CWS2424	94	24	24
		CWS2430	101	24	30
		CWS2436	114	24	36
		CWS2442	147	24	42
		CWS2448	177	24	48
		CWS2454	207	24	54
		CWS2460	232	24	60
		CWS2466	243	24	66
		CWS2472	253	24	72
		CWS2478	408	24	78
		CWS2484	412	24	84
		CWS2490	432	24	90
		CWS2496	462	24	96
	Rectangular Worksurfaces - 30" Deep	CWS3024	111	30	24
		CWS3030	118	30	30
		CWS3036	140	30	36
		CWS3042	197	30	42
		CWS3048	207	30	48
		CWS3054	228	30	54
		CWS3060	243	30	60
		CWS3066	252	30	66
		CWS3072	267	30	72
		CWS3078	508	30	78
		CWS3084	516	30	84

## CWSP - RECTANGULAR WORKSURFACES - SPAN A POST

- All tops are thermally fused 1" thick with pilot holes to enable proper alignment with worksurface supports. Wood screws must be used.
- Compile worksurfaces feature a 3mm edge.
- Support hardware must be ordered separately. See the listings in this section.
- Note: Width and depth dimensions listed include a nominal measurement (3/8") to account for wire management between the worksurface and adjoining panel.

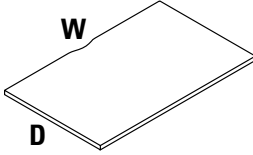
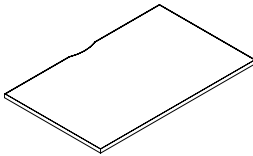
	DESCRIPTION	PRODUCT CODE	LIST PRICE	DIMENSIONS/INCHES	
				D	W
	Rectangular Worksurfaces - 24" Deep Span a Post	CWSP2426	114	24	26
		CWSP2432	137	24	32
		CWSP2438	160	24	38
		CWSP2444	182	24	44
		CWSP2450	205	24	50
		CWSP2456	228	24	56
		CWSP2462	301	24	62
		CWSP2468	328	24	68
		CWSP2474	356	24	74
		CWSP2480	383	24	80
		CWSP2486	438	24	86
	Rectangular Worksurfaces - 30" Deep Span a Post	CWSP3026	143	30	26
		CWSP3032	171	30	32
		CWSP3038	204	30	38
		CWSP3044	228	30	44
		CWSP3050	256	30	50
		CWSP3056	285	30	56
		CWSP3062	376	30	62
		CWSP3068	410	30	68
		CWSP3074	445	30	74
		CWSP3080	479	30	80
		CWSP3086	547	30	86



# WORKSURFACES

## CWVR - CURVILINEAR WORKSURFACES - RIGHT

- All tops are thermally fused 1" thick with pilot holes to enable proper alignment with worksurface supports. Wood screws must be used.
- Compile worksurfaces feature a 3mm edge.
- When deepest end equals 24". the opposite depth is 18". When deepest end equals 30", the opposite depth is 24"
- Support hardware must be ordered separately. See the listings in this section.
- Note: Width and depth dimensions listed include a nominal measurement (3/8") to account for wire management between the worksurface and adjoining panel.

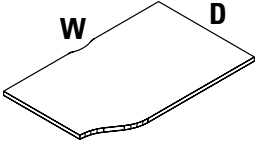
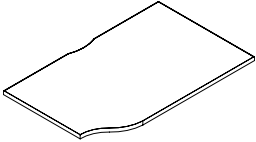
	DESCRIPTION	PRODUCT CODE	LIST PRICE	DIMENSIONS/INCHES	
				D	W
	Curvilinear Worksurfaces - 24" Deep	CWVR2424	122	24	24
		CWVR2430	127	24	30
		CWVR2436	152	24	36
		CWVR2442	177	24	42
		CWVR2448	203	24	48
		CWVR2454	228	24	54
		CWVR2460	247	24	60
		CWVR2466	273	24	66
		CWVR2472	293	24	72
		CWVR2478	408	24	78
	CWVR2484	412	24	84	
	Curvilinear Worksurfaces - 30" Deep	CWVR3024	127	30	24
		CWVR3030	133	30	30
		CWVR3036	159	30	36
		CWVR3042	218	30	42
		CWVR3048	228	30	48
		CWVR3054	252	30	54
		CWVR3060	273	30	60
		CWVR3066	293	30	66
		CWVR3072	311	30	72
		CWVR3078	508	30	78
	CWVR3084	516	30	84	

## CWVL - CURVILINEAR WORKSURFACES - LEFT

- All tops are thermally fused 1" thick with pilot holes to enable proper alignment with worksurface supports. Wood screws must be used.
- Compile worksurfaces feature a 3mm edge.
- When deepest end equals 24". the opposite depth is 18". When deepest end equals 30", the opposite depth is 24"
- Support hardware must be ordered separately. See the listings in this section.
- Note: Width and depth dimensions listed include a nominal measurement (3/8") to account for wire management between the worksurface and adjoining panel.

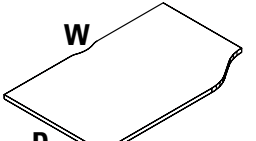
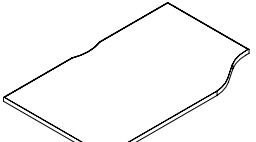
	DESCRIPTION	PRODUCT CODE	LIST PRICE	DIMENSIONS/INCHES	
				D	W
	Curvilinear Worksurfaces - 24" Deep	CWVL2424	122	24	24
		CWVL2430	127	24	30
		CWVL2436	152	24	36
		CWVL2442	177	24	42
		CWVL2448	203	24	48
		CWVL2454	228	24	54
		CWVL2460	247	24	60
		CWVL2466	273	24	66
		CWVL2472	293	24	72
		CWVL2478	408	24	78
	CWVL2484	412	24	84	
	Curvilinear Worksurfaces - 30" Deep	CWVL3024	127	30	24
		CWVL3030	133	30	30
		CWVL3036	159	30	36
		CWVL3042	218	30	42
		CWVL3048	228	30	48
		CWVL3054	252	30	54
		CWVL3060	273	30	60
		CWVL3066	293	30	66
		CWVL3072	311	30	72
		CWVL3078	508	30	78
	CWVL3084	516	30	84	

# WORKSURFACES

## CWCC - CORNER CURVED WORKSURFACES

- All tops are thermally fused 1" thick with pilot holes to enable proper alignment with worksurface supports. Wood screws must be used.
- Compile worksurfaces feature a 3mm edge.
- Support hardware must be ordered separately. See the listings in this section.
- Note: Width and depth dimensions listed include a nominal measurement (38") to account for wire management between the worksurface and adjoining panel.
- Note: Wood grain laminates do not run diagonally on corner worksurfaces.

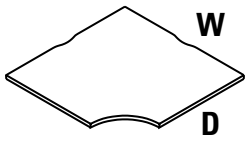
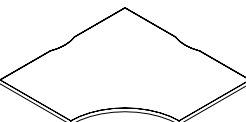
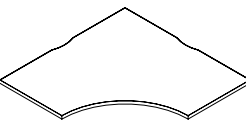
	DESCRIPTION	PRODUCT CODE	LIST PRICE	DIMENSIONS/INCHES	
				D	W
	Corner Curved Worksurfaces - 36"	CWCC3618	321	18	36
		CWCC3624	351	24	36
	Corner Curved Worksurfaces - 42"	CWCC4224	476	24	42
		CWCC4230	517	30	42
	Corner Curved Worksurfaces - 48"	CWCC4824	556	24	48
		CWCC4830	583	30	48

## CWCF - FIVE SIDED WORKSURFACES

- All tops are thermally fused 1" thick with pilot holes to enable proper alignment with worksurface supports. Wood screws must be used.
- Compile worksurfaces feature a 3mm edge.
- Support hardware must be ordered separately. See the listings in this section.
- Note: Width and depth dimensions listed include a nominal measurement (38") to account for wire management between the worksurface and adjoining panel.
- Note: Wood grain laminates do not run diagonally on corner worksurfaces.

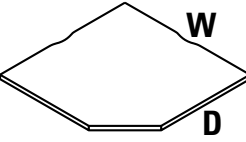
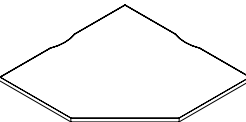
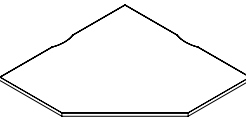
	DESCRIPTION	PRODUCT CODE	LIST PRICE	DIMENSIONS/INCHES	
				D	W
	Five Sided Worksurface - 36"	CWCF3618	318	18	36
		CWCF3624	351	24	36
	Five Sided Worksurface - 42"	CWCF4224	476	24	42
		CWCF4230	517	30	42
	Five Sided Worksurface - 48"	CWCF4824	556	24	48
		CWCF4830	583	30	48



# WORKSURFACES

## CWC6 - CURVED CORNER WORKSURFACE FOR 60° POST

- All tops are thermally fused 1" thick with pilot holes to enable proper alignment with worksurface supports. Wood screws must be used.
- Compile worksurfaces feature a 3mm edge.
- Support hardware must be ordered separately. See the listings in this section.
- Note: Width and depth dimensions listed include a nominal measurement (3/8") to account for wire management between the worksurface and adjoining panel.
- Note: Wood grain laminates do not run diagonally on corner worksurfaces.

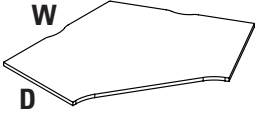
	DESCRIPTION	PRODUCT CODE	LIST PRICE TF	DIMENSIONS/INCHES	
				D	W
	Curved Corner Worksurface for 60° Post - 24"	CWC62424	300	24	24
		CWC62430	533	24	30
		CWC62436	601	24	36
		CWC62442	918	24	42
		CWC62448	1001	24	48
	Curved Corner Worksurface for 60° Post - 30"	CWC63024	300	30	24
		CWC63030	533	30	30
		CWC63036	601	30	36
		CWC63042	918	30	42
		CWC63048	1001	30	48

## CWCEL - EXTENDED CURVED CORNER - LEFT

- There are three cable scoops on this worksurface
- Support hardware must be ordered separately. See listing in this section of the price list
- Note: Wood Grain Laminates do not run diagonally on Extended Curved Corners

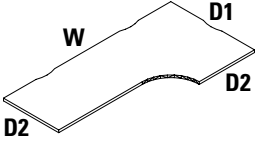
	DESCRIPTION	PRODUCT CODE	LIST PRICE	DIMENSIONS/INCHES		
				D1	D2	W
	Extended Curved Corner - 36" x 24"	CWCEL362448	435	36	24	48
		CWCEL362460	474	36	24	60
		CWCEL362466	521	36	24	66
		CWCEL362472	577	36	24	72
		CWCEL362478	616	36	24	78
		CWCEL362484	663	36	24	84
	Extended Curved Corner - 42" x 24"	CWCEL422460	499	42	24	60
		CWCEL422466	548	42	24	66
		CWCEL422472	607	42	24	72
		CWCEL422478	648	42	24	78
		CWCEL422484	699	42	24	84
	Extended Curved Corner - 42" x 30"	CWCEL423060	562	42	30	60
		CWCEL423066	616	42	30	66
		CWCEL423072	673	42	30	72
		CWCEL423078	722	42	30	78
		CWCEL423084	769	42	30	84
	Extended Curved Corner - 48" x 24"	CWCEL482460	591	48	24	60
		CWCEL482466	639	48	24	66
		CWCEL482472	686	48	24	72
		CWCEL482478	755	48	24	78
		CWCEL482484	785	48	24	84
	Extended Curved Corner - 48" x 30"	CWCEL483060	625	48	30	60
		CWCEL483066	681	48	30	66
		CWCEL483072	739	48	30	72
		CWCEL483078	794	48	30	78
		CWCEL483084	830	48	30	84

# WORKSURFACES

## CWCER - EXTENDED CURVED CORNER - RIGHT

- There are three cable scoops on this worksurface
- Support hardware must be ordered separately. See listing in this section of the price list
- Note: Wood Grain Laminates do not run diagonally on Extended Curved Corners

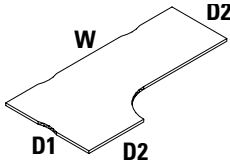
	DESCRIPTION	PRODUCT CODE	LIST PRICE	DIMENSIONS/INCHES		
				D1	D2	W
	Extended Curved Corner - 36" x 24"	CWCER362448	435	36	24	48
		CWCER362460	474	36	24	60
		CWCER362466	521	36	24	66
		CWCER362472	577	36	24	72
		CWCER362478	616	36	24	78
	CWCER362484	663	36	24	84	
	Extended Curved Corner - 42" x 24"	CWCER422460	499	42	24	60
		CWCER422466	548	42	24	66
		CWCER422472	607	42	24	72
		CWCER422478	648	42	24	78
		CWCER422484	699	42	24	84
	Extended Curved Corner - 42" x 30"	CWCER423060	562	42	30	60
		CWCER423066	616	42	30	66
		CWCER423072	673	42	30	72
		CWCER423078	722	42	30	78
CWCER423084		769	42	30	84	
Extended Curved Corner - 48" x 24"	CWCER482460	591	48	24	60	
	CWCER482466	639	48	24	66	
	CWCER482472	686	48	24	72	
	CWCER482478	755	48	24	78	
	CWCER482484	785	48	24	84	
Extended Curved Corner - 48" x 30"	CWCER483060	625	48	30	60	
	CWCER483066	681	48	30	66	
	CWCER483072	739	48	30	72	
	CWCER483078	794	48	30	78	
	CWCER483084	830	48	30	84	

## CWD - "D" WORKSURFACE

- Support hardware must be ordered separately. See listing in this section of the price list
- Monoleg is included

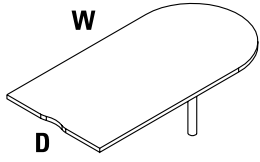
	DESCRIPTION	PRODUCT CODE	LIST PRICE	DIMENSIONS/INCHES		
				D	W	
	"D" Worksurface - 24"	CWD2442	355	24	42	
		CWD2448	365	24	48	
		CWD2460	383	24	60	
		CWD2472	410	24	72	
	"D" Worksurface - 30"	CWD3042			30	42
		CWD3048	390		30	48
		CWD3060	410		30	60
		CWD3072	455		30	72



# WORKSURFACES

## CWH - HATCHET WORKSURFACE (LEFT SHOWN)

- Cable scoop is in the center of the 36" wide edge.
- Support hardware must be ordered separately. See listing in this section of the price list
- Monoleg is included
- Must be specified either left or right handed.
- Note: Wood Grain Laminates do not run diagonally on Hatchet Corners

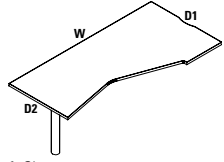
	DESCRIPTION	PRODUCT CODE	LIST PRICE	DIMENSIONS/INCHES		
				D1	D2	W
 <p>Left Shown</p>	Hatchet Worksurface - Left	CWHL3672	784	36	30	72
	Hatchet Worksurface - Right	CWHR3672	784	36	30	72

## CWSW - STRAIGHT WEDGE WORKSURFACES

- Support hardware must be ordered separately. See the listings in this section.
- Must be specified either left or right handed.

	DESCRIPTION	PRODUCT CODE	LIST PRICE	DIMENSIONS/INCHES			
				D1	D2	W	
	Straight Wedge Worksurface - Left	CWSW241848	248	24	18	48	
		CWSW241854	279	24	18	54	
		CWSW241860	308	24	18	60	
		CWSW241866	341	24	18	66	
		CWSW241872	371	24	18	72	
			CWSW302448	308	30	24	48
			CWSW302454	348	30	24	54
			CWSW302460	387	30	24	60
			CWSW302466	425	30	24	66
			CWSW302472	465	30	24	72
	Straight Wedge Worksurface - Right	CWSW182448	248	18	24	48	
		CWSW182454	279	18	24	54	
		CWSW182460	308	18	24	60	
		CWSW182466	341	18	24	66	
		CWSW182472	371	18	24	72	
			CWSW243048	308	24	30	48
			CWSW243054	348	24	30	54
			CWSW243060	387	24	30	60
			CWSW243066	425	24	30	66
			CWSW243072	465	24	30	72

## CWQR - QUARTER ROUND PANEL WORKSURFACE

- The worksurface edge running along the panel is a slightly different length than that of the worksurface end, causing the surface to be handed.
- Left hand surface shown.
- Support hardware must be ordered separately. See the listings in this section.

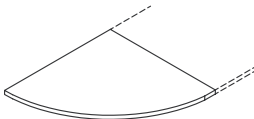
	DESCRIPTION	PRODUCT CODE	LIST PRICE	DIMENSIONS/INCHES	
				D	W
	Quarter Round Panel Worksurface - Left	CWQRL2424	147	24	24
		CWQRL3030	194	30	30
	Quarter Round Panel Worksurface - Right	CWQRR2424	147	24	24
		CWQRR3030	194	30	30

# WORKSURFACES

## CWQRC - QUARTER ROUND PANEL CORNER WORKSURFACE

- Wraps around a 90° corner post.
- Support hardware must be ordered separately. See the listing in this section.

DESCRIPTION	PRODUCT CODE	LIST PRICE	DIMENSIONS/INCHES	
			D	W
Quarter Round Panel Corner Worksurface	CWQRC2424	176	24	24
	CWQRC3030	217	30	30

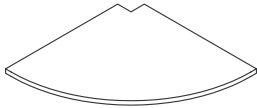

## CWT - STRAIGHT TRANSACTION WORKSURFACE

- Support hardware must be ordered separately. See the listings in this section.
- Compile worksurfaces feature a 3mm edge.

DESCRIPTION	PRODUCT CODE	LIST PRICE	DIMENSIONS/INCHES	
			D	W
Straight Transaction Worksurface	CWT1512	43	15	12
	CWT1518	57	15	18
	CWT1524	68	15	24
	CWT1530	82	15	30
	CWT1536	93	15	36
	CWT1542	106	15	42
	CWT1548	120	15	48
	CWT1554	130	15	54
	CWT1560	145	15	60
	CWT1566	156	15	66
	CWT1572	169	15	72
	CWT1578	182	15	78
	CWT1584	193	15	84

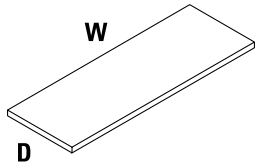

## CWTE - END TRANSACTION SURFACE

- Support hardware must be ordered separately. See the listings in this section.
- Extends 1.5" past end of run.
- Compile worksurfaces feature a 3mm edge.

DESCRIPTION	PRODUCT CODE	LIST PRICE	DIMENSIONS/INCHES	
			D	W
End Transaction Surface	CWTE1512	57	15	14
	CWTE1518	68	15	20
	CWTE1524	82	15	26
	CWTE1530	93	15	32
	CWTE1536	106	15	38
	CWTE1542	120	15	44
	CWTE1548	130	15	50
	CWTE1554	145	15	56
	CWTE1560	156	15	62
	CWTE1566	169	15	68
	CWTE1572	182	15	74

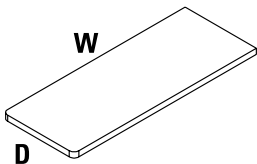

# WORKSURFACES

## CWTCL - "L" CORNER TRANSACTION SURFACE

- Support hardware must be ordered separately. See the listings in this section.
- When specifying this item along with a straight surface, deduct 12" from each return side.

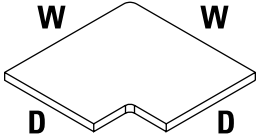
	DESCRIPTION	PRODUCT CODE	LIST PRICE	DIMENSIONS/INCHES	
				D	W
	"L" Corner Transaction Surface	CWTCL90	123	15	21

## CW9T - CORNER TRANSACTION SURFACE FOR 90° POST

- Support hardware must be ordered separately. See the listing in this section.

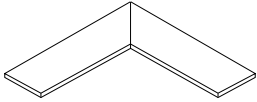
	DESCRIPTION	PRODUCT CODE	LIST PRICE	DIMENSIONS/INCHES	
				D	W
	Corner Transaction Surface for 90° Post	CW9T1524	168	15	32.861
		CW9T1530	201	15	38.861
		CW9T1536	231	15	44.861
		CW9T1542	264	15	50.861
		CW9T1548	299	15	56.861

## CHCB2 - CORNER BRACKET

- Attaches the corner of any worksurface to a panel connector.
- Priced and shipped in pairs.
- Available in standard paint colors.
- Cannot be used off modular.
- Can be used when a panel is the same depth as the worksurface in the front and back application.

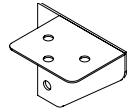
	DESCRIPTION	PRODUCT CODE	LIST PRICE	DIMENSIONS/INCHES	
				D	W
	Corner Bracket	CHCB2	13	2.5	

## CHWB1 - MID SPAN SUPPORT BRACKET

- Does not need to be on module.
- Used when a panel exceeds the depth of the adjacent worksurface.
- Can only be used with a Segmented Panel.
- Comes in unfinished zinc.

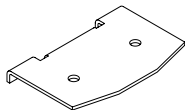
	DESCRIPTION	PRODUCT CODE	LIST PRICE	DIMENSIONS/INCHES	
				D	W
	Mid Span Support Bracket	CHWB1	7		



# WORKSURFACES

## CHC15 & CHC222- CANTILEVER

- Attaches a worksurface to a panel.
- Used to support two convergent worksurfaces when specified with 2 Flat Brackets.
- Does not include Flat Brackets.
- Priced individually
- Specify handedness of each cantilever
- Available in standard paint colors.
- Right and left Cantilever needs to be specified unless flat brackets are also specified.

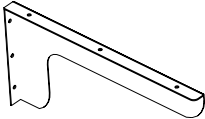
	DESCRIPTION	PRODUCT CODE	LIST PRICE	DIMENSIONS/INCHES	
				D	W
	Cantilever - 15"	CHC15L	32	15	6
		CHC15R	32	15	6
	Cantilever - 22"	CHC22L	52	22	6
		CHC22R	52	22	6

## CMHC - WORKSURFACE SUPPORT CHANNEL

- Support channel attaches to underside of worksurface with screws
- Support channel should be 14" shorter than top length.
- Screws are included.
- Only available in Black.
- Tops with post legs should be specified with support channel for structural reinforcement.

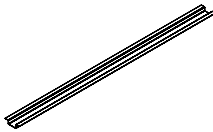
	DESCRIPTION	PRODUCT CODE	LIST PRICE	DIMENSIONS/INCHES	
				L	D
	Worksurface Support Channel	CMHC40 - for 54" wide table	56	40	5
		CMHC46 - for 60" wide table	62	46	5
		CMHC52 - for 66" wide table	68	52	5
		CMHC58 - for 72" wide table	77	58	5
		CMHC64 - for 78" wide table	84	64	5
		CMHC70 - for 84" wide table	93	70	5

## CHFB1 - FLAT BRACKET

- Use in conjunction with Cantilever to make it a shared Cantilever to support convergent worksurfaces.
- Used at the front of 2 convergent worksurfaces to keep worksurfaces flush at seams.
- Available in Black only.

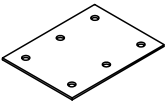
	DESCRIPTION	PRODUCT CODE	LIST PRICE	DIMENSIONS/INCHES	
				D	W
	Flat Bracket	CHFB1	12	3	4

## CHTB2 - TRANSACTION TOP BRACKETS

- Securely attaches a transaction surface to the top of a panel.
- One pair must be on each side of transaction surface.
- Priced and shipped in pairs.
- Available in Anodized Aluminum only.

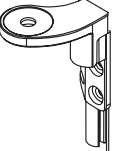
	DESCRIPTION	PRODUCT CODE	LIST PRICE	DIMENSIONS/INCHES	
				D	W
	Transaction Top Brackets	CHTB2	17		



# WORKSURFACES

## CHEP - END PANEL

- Supports the worksurface and enhances the stability of connected panels.
- Provides solid support at the end of a run of worksurfaces.
- Finished in thermally-fused laminate.
- Includes flat brackets and hardware.
- End panel height is inclusive of panel glides extended to their fullest height.
- If wood grains is selected, grain runs vertically.

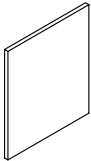
	DESCRIPTION	PRODUCT CODE	LIST PRICE	DIMENSIONS/INCHES	
				D	W
	End Panel - 28"High	CHEP2924	182	28	24
		CHEP2930	213	28	30

## CHMSL - MID SUPPORT LEG

- Provides support for a worksurface.
- Includes leveling glide, PVC Sleeve and 4.8" x 4.8" attachment plate.
- 1.5" diameter.
- Available in standard paint colors.

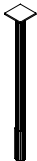
	DESCRIPTION	PRODUCT CODE	LIST PRICE	DIMENSIONS/INCHES
				H
	Mid Support Leg - Round	CHMSL1	62	28
	Mid Support Leg - Square	CHMSL2	62	28

## CMHCL & CHHCL - CORNER LEG WITH LEVELER

- Provides support for a worksurface.
- Includes leveling glide, PVC Sleeve and attachment plate.
- 1.5" diameter
- Available in standard paint colors.
- Legs can be used in the corner of a single worksurface or be rotated 45 degrees to support the corners of two worksurfaces.

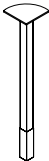
	DESCRIPTION	PRODUCT CODE	LIST PRICE	DIMENSIONS/INCHES
				H
 	Corner Leg Round	CMHCL1	87	28
	Corner Leg Square	CHHCL2	87	28

# WORKSURFACES

## CHMEGR - METAL END GABLE - RIGHT

- Supports the worksurface and enhances the stability of connected panels.
- Includes a levelling glide and decorative PVC sleeve to cover the glide.
- Available in standard paint colors.

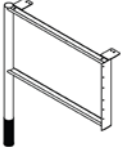
DESCRIPTION	PRODUCT CODE	LIST PRICE	DIMENSIONS/INCHES		
			H	D	W
 Metal End Gable - Right	CHMEG18R	184	28	17	4
	CHMEG24R	195	28	23	4
	CHMEG30R	206	28	29	4

## CHMEGL - METAL END GABLE - LEFT

- Supports the worksurface and enhances the stability of connected panels.
- Includes a levelling glide and decorative PVC sleeve to cover the glide.
- Available in standard paint colors.

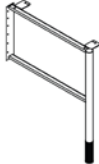
DESCRIPTION	PRODUCT CODE	LIST PRICE	DIMENSIONS/INCHES		
			H	W	D
 Metal End Gable - Left	CHMEG18L	184	28	17	4
	CHMEG24L	195	28	23	4
	CHMEG30L	206	28	29	4

## CHMSL - METAL SUPPORT LEG

- Supports two adjoining worksurfaces and enhances the stability of connected panels.
- Includes a levelling glide and decorative PVC sleeve to cover the glide.
- Available in standard paint colors.
- Flat brackets recommended to ensure alignment of neighboring surface.

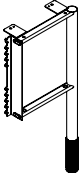
DESCRIPTION	PRODUCT CODE	LIST PRICE	DIMENSIONS/INCHES		
			H	W	D
 Metal Support Leg	CHMSL12	163	28	11	4

## PEDESTAL FILLER BRACKET

- Screws to back of pedestal
- Fills the gap between the pedestal and panel when wing pnael is not used.

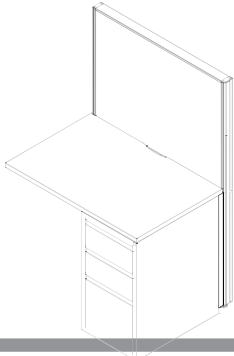
DESCRIPTION	PRODUCT CODE	LIST PRICE	DIMENSIONS/INCHES	
			D	W
 Pedestal Filler Bracket-	CHPBF	37	26.875	1.375



storage

## LATERAL FILE FEATURES

### DRAWERS/SHELVES

- Drawer interlocking system
- Three-stage, anti-bounceback suspension
- Pre-installed, side-to-side file bars for letter, legal and A4
- Front-to-back file bars – optional
- Full-height dividers – optional
- Angled full pull

### CONSTRUCTION

- Top stiffener bar
- Corner gussets
- Four (4) ganging drill points are marked to ensure correct positioning
- Cam lock included
- Leveling glides
- Counterweights are included in 2, 3 and 4 drawer cabinets. BIFMA does not require counterweight in 5 drawer cabinets.

## PEDESTAL FEATURES

### DRAWERS/SHELVES

- All drawer fronts feature a recessed, angled full pull.
- Drawers feature ball bearing suspension.

### CONSTRUCTION

- Central Core removable cam locks.
- Pedestals are 15" wide.
- Counterweight is standard on all Freestanding models.
- Worksurfaces supporting models have holes drilled in top to attach underneath a worksurface.

## STANDARD PAINT COLORS

BLACK	BLK
DESIGNER WHITE	DWT
NEVADA	NEV
STEEL	STL

## GENERAL WARRANTY INFORMATION

- Evolve warrants all components of metal storage and filing for the lifetime of the product to the original purchaser.



This page provides a three dimensional view of a sample configuration highlighting each storage component required when specifying this configuration.

## Components

- A. CSOF13XX KD Overhead
- B. CSSL13XX Low-Profile Shelf
- C. CM19XXBBF Worksurface Supporting Box, Box, File Pedestal

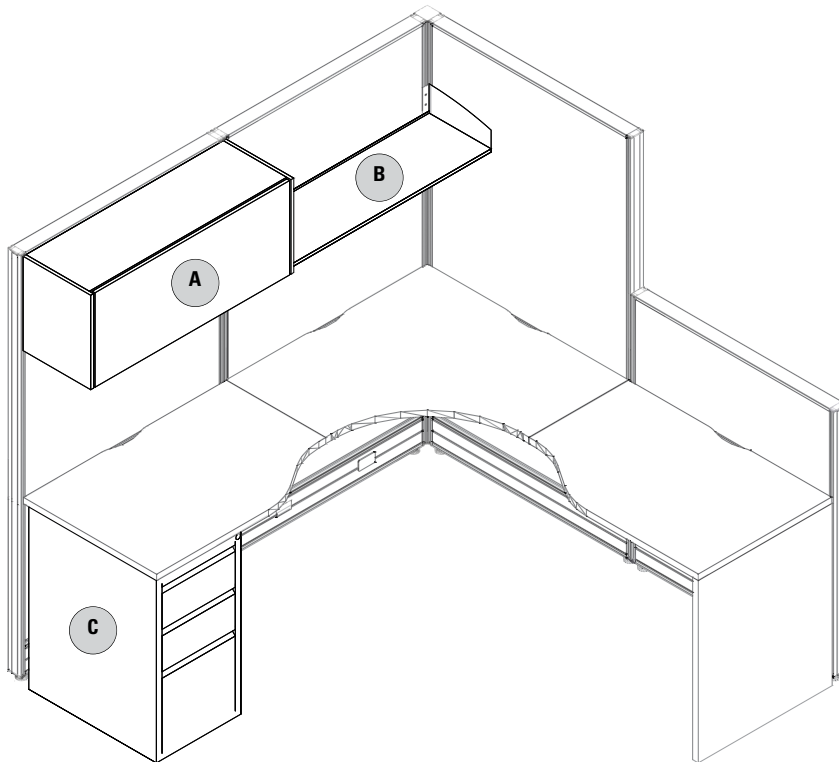

# STORAGE

## CS19XXBBF - WORKSURFACE SUPPORTING BOX/BOX/FILE 15" PEDESTAL

- Worksurface supporting, with predrilled holes in the top.
- Also available as freestanding with finished top.
- All drawer fronts feature a recessed, angled full pull.
- Pedestal height shown includes glide.
- Pencil tray and Lock included.
- File Bars are not included with Compile pedestals. To order file bars, use product code CSPEDHFB at \$15.00 each list.

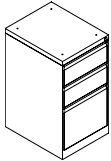
	DESCRIPTION	PRODUCT CODE	LIST PRICE	DIMENSIONS/INCHES		
				H	D	W
	Worksurface Supporting Box/Box/File 15" Pedestal	CS1919BBF	330	27 5/8	18 5/8	15
		CS1923BBF	340	27 5/8	22 5/8	15
		CS1929BBF	385	27 5/8	29 5/8	15

## CS19XXFF - WORKSURFACE SUPPORTING FILE/FILE 15" PEDESTAL

- Worksurface supporting, with predrilled holes in the top.
- Also available as freestanding with finished top.
- All drawer fronts feature a recessed, angled full pull.
- Pedestal height shown includes glide.
- Lock included.
- File Bars are not included with Compile pedestals. To order file bars, use product code CSPEDHFB at \$15.00 each list.

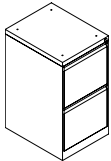
	DESCRIPTION	PRODUCT CODE	LIST PRICE	DIMENSIONS/INCHES		
				H	D	W
	Worksurface Supporting File/File 15" Pedestal	CS1919FF	330	27 5/8	18 5/8	15
		CS1923FF	340	27 5/8	22 5/8	15
		CS1929FF	385	27 5/8	29 5/8	15

## CS19FXBBF - FREESTANDING BOX/BOX/FILE 15" PEDESTAL

- All drawer fronts feature a recessed, angled full pull.
- Pedestal height shown includes glide.
- Finished top.
- Counterweight, Pencil tray and Lock included.
- File Bars are not included with Compile pedestals. To order file bars, use product code CSPEDHFB at \$15.00 each list.

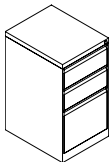
	DESCRIPTION	PRODUCT CODE	LIST PRICE	DIMENSIONS/INCHES		
				H	D	W
	Freestanding Box/Box/File 15" Pedestal	CS19F19BBF	340	27 5/8	18 5/8	15
		CS19F23BBF	350	27 5/8	22 5/8	15
		CS19F29BBF	395	27 5/8	29 5/8	15

## CS19FXFF - FREESTANDING FILE/FILE 15" PEDESTAL

- All drawer fronts feature a recessed, angled full pull.
- Pedestal height shown includes glide.
- Finished top.
- Counterweight and Lock included.
- File Bars are not included with Compile pedestals. To order file bars, use product code CSPEDHFB at \$15.00 each list.

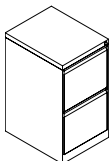
	DESCRIPTION	PRODUCT CODE	LIST PRICE	DIMENSIONS/INCHES		
				H	D	W
	Freestanding File/File 15" Pedestal	CS19F19FF	340	27 5/8	18 5/8	15
		CS19F23FF	350	27 5/8	22 5/8	15
		CS19F29FF	395	27 5/8	29 5/8	15



# STORAGE

## CS19MPXXBBF - MOBILE BOX/BOX/FILE PEDESTAL

- All drawer fronts feature a recessed, angled full pull.
- Pedestal height shown includes glide.
- Finished top.
- Counterweight, Pencil tray, and Lock included.
- File Bars are not included with Compile pedestals. To order file bars, use product code CSPEDHFB at \$15.00 each list.

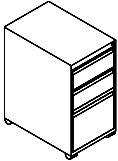
	DESCRIPTION	PRODUCT CODE	LIST PRICE	DIMENSIONS/INCHES		
				H	D	W
	Mobile Box/Box/File Pedestal	CS19MP19BBF	450	27 5/8	18 5/8	15
		CS19MP23BBF	475	27 5/8	22 5/8	15

## CS19MPXXFF - MOBILE FILE/FILE PEDESTAL

- All drawer fronts feature a recessed, angled full pull.
- Pedestal height shown includes glide.
- Finished top.
- Counterweight and Lock included.
- File Bars are not included with Compile pedestals. To order file bars, use product code CSPEDHFB at \$15.00 each list.

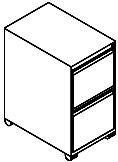
	DESCRIPTION	PRODUCT CODE	LIST PRICE	DIMENSIONS/INCHES		
				H	D	W
	Mobile File/File Pedestal	CS19MP19FF	450	27 5/8	18 5/8	15
		CS19MP23FF	475	27 5/8	22 5/8	15

## CSMCPXXBFNC - MOBILE BOX/FILE PEDESTAL WITH 60MM CASTERS

- Mobile pedestal that includes one pencil tray and one divider.
- Includes factory installed counterweight.
- Lock is standard.
- 60mm high castors.
- For use with pedestal seat cushion. See model below.
- Casters do not lock.

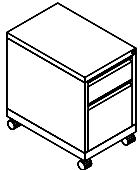
	DESCRIPTION	PRODUCT CODE	LIST PRICE	DIMENSIONS/INCHES		
				H	D	W
	Mobile Box/File Pedestal with 60mm Castors	CSMCP19BFNC	490	23.875	18.625	15
		CSMCP23BFNC	500	23.875	22.625	15



# STORAGE

## CSCUSH15 - PEDESTAL SEAT CUSHIONS

- Cushions will have single stitching at the seams.
- Velcro included for quick attachment to pedestal file.
- 1" Cushion will have a rectilinear design on all sides.
- 2" Cushion will have waterfall edges Front and Back,
- Cushions are for use on CSMCPXXBFNC Mobile Pedestals.
- Please choose a fabric from the standard cushion textiles on pages 94-96

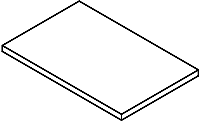
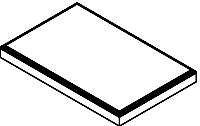
DESCRIPTION	PRODUCT CODE	LIST PRICE/GRADES																	DIM./INCH			YRDS
		3	4	5	6	7	8	9	10	11	12	13	14	15	16	17	18	19	H	D	W	
 Pedestal Seat Cushions - 1" Thick	CSCUSH15X18-5/8x1	133	155	172	198	234	251	284	337	378	423	516	615	636	724	901	1077	1254	1	18.625	15	1
	CSCUSH15X22-5/8x1	150	172	189	215	251	268	301	354	395	440	533	632	651	739	916	1092	1269	1	22.625	15	1
 Pedestal Seat Cushions - 2" Thick	CSCUSH15X18-5/8x1	148	169	186	212	249	266	299	351	392	437	529	630	820	938	1173	1408	1644	2	18.625	15	2
	CSCUSH15X22-5/8-2	148	169	186	212	249	266	299	351	392	437	529	630	729	828	1026	1225	1424	2	22.625	15	2

## CSSL13 - LOW PROFILE SHELF

- 13" deep panel-mounted storage shelf with backlip.
- Mounting brackets are included.

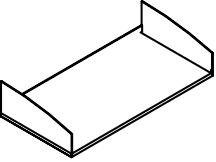
DESCRIPTION	PRODUCT CODE	LIST PRICE	DIMENSIONS/INCHES		
			H	D	W
 Low Profile Shelf - 13"	CSSL1324	80	14.5	13	24
	CSSL1330	89	14.5	13	30
	CSSL1336	96	14.5	13	36
	CSSL1342	104	14.5	13	42
	CSSL1348	109	14.5	13	48
	CSSL1354	114	14.5	13	54
	CSSL1360	119	14.5	13	60

## CSOF13 - KD OVERHEAD

- Mounting brackets are included.
- Door retracts up and over the cabinet
- Ready for quick assembly on site.
- Quality steel construction.
- 60" unit is reinforced for proper weight distribution.
- Inside dimensions: 12" h x 12.75" d
- Lock sold separately, see model CMSLK13 - list price \$25 each.

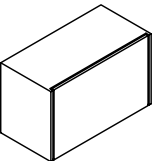
DESCRIPTION	PRODUCT CODE	LIST PRICE	DIMENSIONS/INCHES		
			H	D	W
 KD Overhead - 13"	CSOF1324	214	14.5	13	24
	CSOF1330	235	14.5	13	30
	CSOF1336	260	14.5	13	36
	CSOF1342	275	14.5	13	42
	CSOF1348	290	14.5	13	48
	CSOF1354	328	14.5	13	54
	CSOF1360	355	14.5	13	60



# STORAGE

## CMDA0HXX - CENTER MOUNT OVERHEAD

- Inside dimensions 13" high x 13" deep.
- Laminate Overhead. No doors.
- Available in standard Compile laminate finishes.
- Top mount on panels.
- Overhead Support Brackets are included.

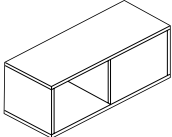
	DESCRIPTION	PRODUCT CODE	LIST PRICE	DIMENSIONS/INCHES		
				H	D	W
	Center Mount Overhead - 13"	CMDA0H36	744	15	13	36
		CMDA0H42	808	15	13	42
		CMDA0H48	845	15	13	48
		CMDA0H54	909	15	13	54
		CMDA0H60	945	15	13	60

## CMSLK13 - LOCK FOR KD OVERHEAD

- Must be specified seperately.

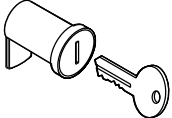
	DESCRIPTION	PRODUCT CODE	LIST PRICE	DIMENSIONS/INCHES		
				H	D	W
	Lock for KD Overhead	CMSLK13	25			

## CMS\_\_ - ADDITIONAL KEY

	DESCRIPTION	PRODUCT CODE	LIST PRICE	DIMENSIONS/INCHES		
				H	D	W
	LOCKKEY - Core and Key	CSLOCKKEY	23			

## CMADAXPM - ADA COMPLIANT OVERHEAD STORAGE UNIT

- Panel Mounted Overhead Storage with metal sides and opaque door that retracts on top of the unit
- Meets CSA B651 Barrier Free Design & ADA (American Disabilities Act).
- 16" high units accept standard and A4 binders.
- All shelves are reinforced for proper weight distribution.
- Inside dimensions: 14.25" high x 12" deep.
- Unit includes attachment hardware, lock and mounting brackets. Back not included.
- Shipped partially assembled.
- Available in standard Compile paint colors only. Door made of opaque plastic. \*\*add 10% upcharge for Tungsten

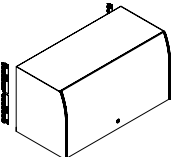
	DESCRIPTION	PRODUCT CODE	LIST PRICE	DIMENSIONS/INCHES		
				H	D	W
	ADA Compliant Overhead Storage Unit	CMADA30PM	658	16	14.2	30
		CMADA36PM	710	16	14.2	36
		CMADA42PM	759	16	14.2	42
		CMADA48PM	810	16	14.2	48
		CMADA54PM	861	16	14.2	54
		CMADA60PM	910	16	14.2	60

# STORAGE

## CS19XX-1X1FH - ONE 1/2 HEIGHT FIXED FRONT & ONE 12" FIXED FRONT LATERAL FILE

- 1/2 Height Box Drawer.
- 1 Fixed Drawer Front.
- Includes Lock.
- Lateral File Top is required when not installed under a worksurface.
- Counterweights must be specified on lateral files with pull out drawers, unless worksurface supporting, ganged together or anchored to the floor or wall.

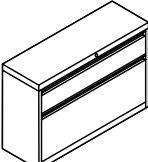
	DESCRIPTION	PRODUCT CODE	LIST PRICE	DIMENSIONS/INCHES		
				H	D	W
	One 1/2 Height Fixed Front &	CS1930-1x1FH	750	21.75	18	30
	One 12" Fixed Front Lateral File	CS1936-1x1FH	800	21.75	18	36
		CS1942-1x1FH	850	21.75	18	42

## CS19XX-1XSND - ONE 1/2 HEIGHT OPEN SHELF & ONE 12" OPEN SHELF LATERAL CABINET

- 1/2 Height Open Shelf.
- Bottom Open Shelf.

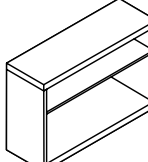
	DESCRIPTION	PRODUCT CODE	LIST PRICE	DIMENSIONS/INCHES		
				H	D	W
	One 1/2 Height Open Shelf &	CS1930-1XSND	375	21.75	18	30
	One 12" Open Shelf Lateral Cabinet	CS1936-1XSND	425	21.75	18	36
		CS1942-1XSND	475	21.75	18	42

## CSCUSH19 - LATERAL SEAT CUSHIONS

- Cushions will have single stitching at the seams,
- Velcro included for quick attachment to lateral file.
- 1" Cushion will have a rectilinear design on all sides.
- 2" Cushion will have waterfall edges Front and Back.
- Please choose a fabric from the standard cushion textiles on pages 244-246.

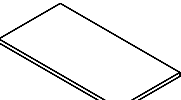
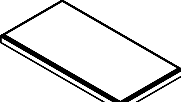
	DESCRIPTION	PRODUCT CODE	LIST PRICE/GRADES													DIM./INCH			YRDS				
			3	4	5	6	7	8	9	10	11	12	13	14	15	16	17	18		19	H	D	W
	Lateral Seat	CSCUSH19-25X30X1	246	275	298	332	382	405	450	521	576	637	762	896	-	-	-	-	-	1	19	30	1
	Cushions - 1" Thick	CSCUSH19-25X36X1	254	283	306	341	390	413	458	529	584	645	770	903	-	-	-	-	-	1	19	36	1
		CSCUSH19-25X42X1	264	292	316	350	399	422	467	538	593	654	779	913	-	-	-	-	-	1	19	42	1
	Lateral Seat	CSCUSH19-25X42X2	273	302	325	359	409	432	476	547	602	663	788	922	-	-	-	-	-	2	19	30	2
	Cushions - 2" Thick	CSCUSH19-25X42X2	281	310	333	367	416	440	484	555	610	671	767	930	-	-	-	-	-	2	198	36	2
		CSCUSH19-25X42X2	290	319	342	377	426	449	493	565	619	680	805	939	-	-	-	-	-	2	18	42	2



# STORAGE

## CWFT - LATERAL FILE TOPS

- Available in standard Compile finishes.

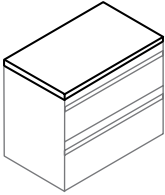
	DESCRIPTION	PRODUCT CODE	LIST PRICE LP	DIMENSIONS/INCHES		
				H	D	W
	Lateral File Tops	CWFT1930	111	1	19.25	30
		CWFT1936	114	1	19.25	36
		CWFT1942	147	1	19.25	42
	2 Lateral Files SBS Top	CWFT1960	232	1	19.25	60
		CWFT1972	253	1	19.25	72
		CWFT1984	412	1	19.25	84
	4 Lateral File BTB Top	CWFT3860	464	1	38.75	60
		CWFT3872	529	1	38.75	72
		CWFT3884	627	1	38.75	84

## CS19XXP - 2F12 - LATERAL FILES - 2 DRAWERS WITH COUNTERWEIGHT

- Counterweight is standard. Two fixed front drawers.
- Side-to-side hanging file bars included.
- Drawers are 12.25" high.
- File cannot be used to store standard three ring binders.
- Lock included.

	DESCRIPTION	PRODUCT CODE	LIST PRICE	DIMENSIONS/INCHES		
				H	D	W
	Lateral Files - 2 Drawers with Counterweight	CS1930P-2F12	595	27.14	19 1/4	30
		CS1936P-2F12	640	27.14	19 1/4	36
		CS1942P-2F12	665	27.14	19 1/4	42

## CS19XXP - 3F12 - LATERAL FILES - 3 DRAWERS WITH COUNTERWEIGHT

- Counterweight is standard. Three fixed front drawers.
- Side-to-side hanging file bars included.
- Drawers are 12.25" high.
- File cannot be used to store standard three ring binders.
- Lock included.

	DESCRIPTION	PRODUCT CODE	LIST PRICE	DIMENSIONS/INCHES		
				H	D	W
	Lateral Files - 3 Drawers with Counterweight	CS1930P-3F12	740	39.52	19 1/4	30
		CS1936P-3F12	780	39.52	19 1/4	36
		CS1942P-3F12	815	39.52	19 1/4	42

# STORAGE

## CS19XXP - 4F12 - LATERAL FILES - 4 DRAWERS WITH COUNTERWEIGHT

- Counterweight is standard. Four fixed front drawers.
- Side-to-side hanging file bars included.
- Drawers are 12.25" high.
- File cannot be used to store standard three ring binders.
- Posting shelf option NOT available.
- Lock included.

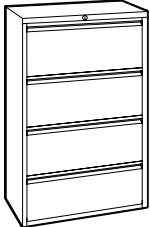
	DESCRIPTION	PRODUCT CODE	LIST PRICE	DIMENSIONS/INCHES		
				H	D	W
	Lateral Files - 4 Drawers with Counterweight	CS1930P-4F12	945	51.89	19 1/4	30
		CS1936P-4F12	990	51.89	19 1/4	36
		CS1942P-4F12	1065	51.89	19 1/4	42

## CS19XXP - 5F12 - LATERAL FILES - 5 DRAWERS

- Four fixed front drawers plus top drawer with receding door and roll-out shelf.
- Side-to-side hanging file bars included.
- Drawers are 12.25" high.
- File cannot be used to store standard three ring binders.
- Posting shelf option NOT available.
- Lock included.

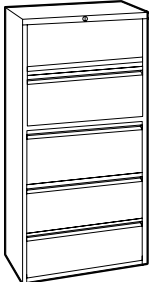
	DESCRIPTION	PRODUCT CODE	LIST PRICE	DIMENSIONS/INCHES		
				H	D	W
	Lateral Files - 5 Drawers	CS1930P-5F12	1125	66.39	19 1/4	30
		CS1936P-5F12	1175	66.39	19 1/4	36
		CS1942P-5F12	1240	66.39	19 1/4	42



SO# \_\_\_\_\_ PO# \_\_\_\_\_ TAG# \_\_\_\_\_ Date \_\_\_\_\_

KEY#	SETS REQ'D	KEY#	SETS REQ'D	KEY#	SETS REQ'D	KEY#	SETS REQ'D	KEY#	SETS REQ'D
401		431		461		491		521	
402		432		462		492		522	
403		433		463		493		523	
404		434		464		494		524	
405		435		465		495		525	
406		436		466		496		526	
407		437		467		497		527	
408		438		468		498		528	
409		439		469		499		529	
410		440		470		500		530	
411		441		471		501		531	
412		442		472		502		532	
413		443		473		503		533	
414		444		474		504		534	
415		445		475		505		535	
416		446		476		506		536	
417		447		477		507		537	
418		448		478		508		538	
419		449		479		509		539	
420		450		480		510		540	
421		451		481		511		541	
422		452		482		512		542	
423		453		483		513		543	
424		454		484		514		544	
425		455		485		515		545	
426		456		486		516		546	
427		457		487		517		547	
428		458		488		518		548	
429		459		489		519		549	
430		460		490		520		550	

401-430 =	431-460 =	461-490 =	491-520 =	521-550 =
-----------	-----------	-----------	-----------	-----------

Total: \_\_\_\_\_

NOTE : If Key Alike Instructions are not submitted to EVOLVE with the Customer's Purchase Order, all components will be keyed randomly.



accessories



# ACCESSORIES

## CATB - TACK BOARD

- Provide a tackable surface for notes and memos in a work area.
- Includes two pairs of panel-mounting brackets.
- Only fabric must be specified.
- 10" to be installed on 42" h panels.
- 21" specified for use under overhead shelf or storage bin.
- 24" for use without any overheads.

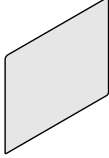
	DESCRIPTION	PRODUCT CODE	LIST PRICE		DIMENSIONS/INCHES		
			Gr1	Gr2	H	W	D
	Tack Board - 10" High	CATB1024	126	132	10	24	
		CATB1030	133	141	10	30	
		CATB1036	148	156	10	36	
		CATB1042	162	172	10	42	
		CATB1048	179	189	10	48	
		CATB1054	197	210	10	54	
		CATB1060	211	225	10	60	
	Tack Board - 21" High	CATB2124	183	189	21	24	
		CATB2130	198	206	21	30	
		CATB2136	226	232	21	36	
CATB2142		257	267	21	42		
CATB2148		289	298	21	48		
CATB2154		317	330	21	54		
Tack Board - 24" High	CATB2160	348	362	21	60		
	CATB2424	183	189	21	24		
	CATB2430	198	206	24	30		
	CATB2436	226	232	24	36		
	CATB2442	257	267	24	42		
	CATB2448	289	298	24	48		
	CATB2454	317	330	24	54		
	CATB2460	348	362	24	60		

## CAWB - WHITE MARKER BOARD

- Provides a writing surface within a work area.
- Includes two pairs of panel-mounting brackets.
- 10" to be installed on 42" h panels.
- 21" specified for use under overhead shelf or storage bin.
- 24" for use without any overheads.

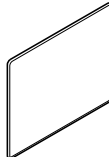
	DESCRIPTION	PRODUCT CODE	LIST PRICE		DIMENSIONS/INCHES		
					H	W	D
	White Marker Board - 10" High	CAWB1030		121	10	30	
		CAWB1036		136	10	36	
		CAWB1042		151	10	42	
		CAWB1048		174	10	48	
White Marker Board - 21" High	White Marker Board - 21" High	CAWB2130		212	21	30	
		CAWB2136		239	21	36	
		CAWB2142		269	21	42	
		CAWB2148		313	21	48	
White Marker Board - 24" High	White Marker Board - 24" High	CAWB2430		212	24	30	
		CAWB2436		239	24	36	
		CAWB2442		269	24	42	
		CAWB2448		313	24	48	



# ACCESSORIES

## CALB - LOAD BAR

- Frame available in Steel (STL), Black (BLK), and Nevada (NEV) only.
- Mounting brackets and clear end caps are included.

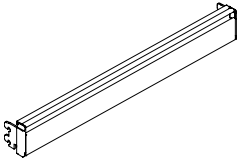
	DESCRIPTION	PRODUCT CODE	LIST PRICE	DIMENSIONS/INCHES		
				H	W	D
	Load Bar	CALB24	102	2.25	24	1
		CALB30	113	2.25	30	1
		CALB36	123	2.25	36	1
		CALB42	143	2.25	42	1
		CALB48	165	2.25	48	1
		CALB54	176	2.25	54	1
		CALB60	189	2.25	60	1

## CSABB01 - BINDER BIN

- Must be ordered in conjunction with a load bar option.
- Available in standard and premium paint selections. See "Textile & Finish Listings" in Introduction for complete list of offerings and conditions.

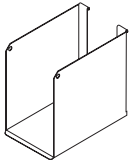
	DESCRIPTION	PRODUCT CODE	LIST PRICE	DIMENSIONS/INCHES		
				H	W	D
	Binder Bin	CSABB01	53	9	4	10.25

## CSALT01 - LETTER TRAY

- Must be ordered in conjunction with a load bar option.
- Available in standard and premium paint selections. See "Textile & Finish Listings" in Introduction for complete list of offerings and conditions.

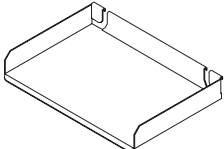
	DESCRIPTION	PRODUCT CODE	LIST PRICE	DIMENSIONS/INCHES		
				H	W	D
	Letter Tray	CSALT01	46	2	13.5	9.25

## CSASS01 - SLANT SORTER

- Must be ordered in conjunction with a load bar option.
- Available in standard and premium paint selections. See "Textile & Finish Listings" in Introduction for complete list of offerings and conditions.

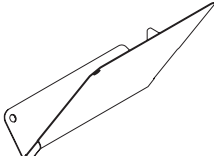
	DESCRIPTION	PRODUCT CODE	LIST PRICE	DIMENSIONS/INCHES		
				H	W	D
	Slant Sorter	CSASS01L	33	9.5	5	10.25
		CSASS01R	33	9.5	5	10.25

# ACCESSORIES

## EVAMB01 - MEDIA BIN

- Must be ordered in conjunction with a load bar option.
- Available in standard and premium paint selections. See "Textile & Finish Listings" in Introduction for complete list of offerings and conditions.

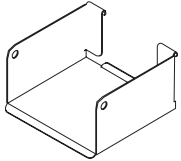
	DESCRIPTION	PRODUCT CODE	LIST PRICE	DIMENSIONS/INCHES		
				H	W	D
	Media Bin	CSAMB01	42	3	5.75	5.25

## CSAUT01 - UTILITY TRAY

- Must be ordered in conjunction with a load bar option.
- Available in standard and premium paint selections. See "Textile & Finish Listings" in Introduction for complete list of offerings and conditions.

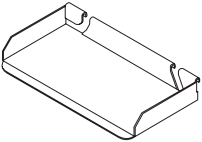
	DESCRIPTION	PRODUCT CODE	LIST PRICE	DIMENSIONS/INCHES		
				H	W	D
	Utility Tray	CSAUT01	28	1	8.5	3.75

## CSAFS01 - FLIP SORTER

- Must be ordered in conjunction with a load bar option. in Introduction for complete list of offerings and conditions.
- Comes with nickel plated wire.
- Available in standard and premium paint selections. See "Textile & Finish Listings"

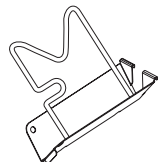
	DESCRIPTION	PRODUCT CODE	LIST PRICE	DIMENSIONS/INCHES		
				H	W	D
	Flip Sorter	CSAFS01	39	9.25	2.75	9.25

## CSAPP01 - MAIL BOX

- Must be ordered in conjunction with a load bar option.
- Available in standard and premium paint selections. See "Textile & Finish Listings" in Introduction for complete list of offerings and conditions.

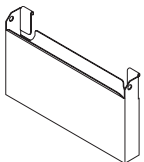
	DESCRIPTION	PRODUCT CODE	LIST PRICE	DIMENSIONS/INCHES		
				H	W	D
	Mail Box	CSAPP01	68	9	12	2.75



# ACCESSORIES

## CSATH01 - TELEPHONE HOLDER

- Must be ordered in conjunction with a load bar option.
- Available in standard and premium paint selections. See "Textile & Finish Listings" in Introduction for complete list of offerings and conditions.

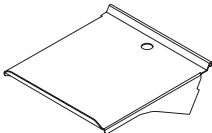
	DESCRIPTION	PRODUCT CODE	LIST PRICE	DIMENSIONS/INCHES		
				H	W	D
	Telephone Holder	CSATH01	65	2	9	10

## CPNP01 - NAME PLATE

- Name Plate attached to 1" increment slots.
- Available in single sided (parallel to panel) or double sided (perpendicular to panel) for isle application displaying name on both sides.
- Injection molded frame and die cast base with black rubberized finish.
- Includes two slide-in name cards, steel brackets and fasteners.
- Available in black only.
- Free template for additional slide-in name cards are available at [http://www.evolvefurnituregroup.com/Product\\_Sheets.html](http://www.evolvefurnituregroup.com/Product_Sheets.html)

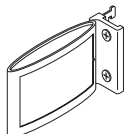
	DESCRIPTION	PRODUCT CODE	LIST PRICE	DIMENSIONS/INCHES		
				H	W	D
	Name Plate	CPNP01	99	3.30	5.3	1.25

## CMCH01 - COAT HOOK

- Coat hook for Compile panels.
- Available in standard Compile paint finishes: DWT, BLK, STL, NEV.

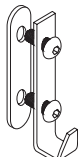
	DESCRIPTION	PRODUCT CODE	LIST PRICE	DIMENSIONS/INCHES		
				H	W	D
	Coat Hook	CMCH01	42	5.5	0.65	1

## CATP91 - TOUCH-UP PAINT KIT

- Available in standard paint colors to facilitate easy touch-ups.
- 1/2 fl. ounce bottle (spray not available).
- Specify color.

	DESCRIPTION	PRODUCT CODE	LIST PRICE	DIMENSIONS/INCHES		
				H	W	D
	Touch-Up Paint Kit	CATP91	32			



# textiles and finishes

## Care and Cleaning

The following guide encompasses the Compile System line.

The guide was compiled using information from our "raw" material suppliers and is relevant only to our standard offering finishes and textiles.

---

### FABRICS

To extend the life of your upholstered panels, regularly dust the panel to prevent airborne particles from penetrating the fabric surface.

For light soiling, use a damp cloth and blot the spot with very slight pressure, taking care never to soak the fabric. Dry with a clean cloth by blotting - never rub fabric. More intense stains can be treated the same way, but with a mild detergent. Always test fabric first in an unseen area before using any cleaning method.

### PANEL FRAMES

The panel frames are manufactured out of sturdy aluminum with a powder coated enamel paint finish. To clean the frames of the panels, and all hardware associated with the Evolve line, simply utilize a clean, damp cloth. For stubborn stains on the panel frames, you may consider adding a mild detergent.

### GLAZED PANELS

Cleaning of the glazing in panels should only be done with a damp lint-free cloth. A mild detergent can be used if necessary. Do not use paper towels in combination with a window cleaner-this may cause scratches to the glazing.

### WORKSURFACES

The worksurfaces are manufactured using primarily Nevamar Brand laminates as the exposed surface. To properly clean these areas, it is best to use a clean, damp cloth and circular motion to prevent streaks. For stubborn stains, you are able to add a mild detergent to the water. Be certain not to use an ammonia-based solution. It will react with the PVC, or wood edge trim, causing permanent damage to the contacted areas.

### ACCESSORIES

The accessories sold with the Evolve product line can be simply cleaned with a clean, damp cloth. If they are really dirty, a mild, non-abrasive solution may be added. Wipe with a damp cloth after the solution, and finally, a dry cloth.

**LAMINATES – THERMALLY FUSED**

Absolute Acajou*	<b>W150LP</b>
Asian Night*	<b>794938LP</b>
Avant Cherry*	<b>W357LP</b>
Avant Honey*	<b>W356LP</b>
Black*	<b>1595-60LP</b>
Blizzard	<b>BZDLP</b>
Brushed Cobalt	<b>BRCLP</b>
Clear Maple*	<b>WM8340TLP</b>
Constellation Java*	<b>T823</b>
Custom Grey	<b>S548LP</b>
Dark Espresso*	<b>W142LP</b>
Desert Zephyr	<b>4841-60LP</b>
Empire Mahogany+	<b>7122T-07LP</b>
Grey	<b>T551</b>
Grey Matrix	<b>MR61TLP</b>
Hayden Grey (Taupe)*	<b>S427LP</b>
Loden Zephyr	<b>4844-60LP</b>
Manitoba Maple	<b>7911-60LP</b>
Misted Zephyr	<b>4843-60LP</b>
Pearl Bisque	<b>D485-07LP</b>
Pearl Dust*	<b>D488-07LP</b>
Shaker Cherry*	<b>7935-07LP</b>
Storm Grey	<b>T565</b>
Stone Dust	<b>SDTLP</b>
Studio White Matrix	<b>MR71TLP</b>
String	<b>S477</b>
Tiger Fruitwood*	<b>T821</b>
Tiger Mahogany*	<b>T822</b>
Tiger Maple*	<b>T820</b>
Tiger Walnut*	<b>T819</b>
Titanium	<b>4810-60LP</b>
True White	<b>S645LP</b>
Willow Grey	<b>T431</b>
Winter Cherry	<b>WCRLP</b>
White Chocolate*	<b>T492LP</b>

Additional paint and laminates may be available. Contact Evolve Customer Support for details.

\* Matching Wood Grain PVC edge available.

+ For matching purposes Empire Mahogany laminate can be coordinated with Global's Quartered Mahogany laminate and PVC trim.

**PVC EDGE TRIM**

Absolute Acajou	<b>AAE</b>
Asian Night	<b>ASE</b>
Avant Cherry	<b>ACE</b>
Avant Honey	<b>AHE</b>
Black	<b>BLK</b>
Charcoal	<b>CHR</b>
Clear Maple	<b>CME</b>
Constellation Java	<b>CSJ</b>
Dark Espresso*	<b>DES</b>
Designer White	<b>DWT</b>
Figured Mahogany	<b>MAF</b>
Nevada	<b>NEV</b>
Pearl Dust	<b>PDE</b>
Quartered Mahogany	<b>QTM</b>
Shaker Cherry	<b>SKE</b>
Silver	<b>SIL</b>
Taupe	<b>TPE</b>
Tiger Fruitwood*	<b>TFW</b>
Tiger Mahogany	<b>TMA</b>
Tiger Maple*	<b>TMP</b>
Tiger Walnut*	<b>TWL</b>
Tungsten	<b>TUN</b>
White Chocolate	<b>CBE</b>

**PAINT & FRAME COLORS**

(for application to trim, steel components, PVC, vertical and horizontal members)

Black	<b>BLK</b>
Designer White	<b>DWT</b>
Nevada	<b>NEV</b>
Steel	<b>STL</b>

**ACCENT PAINTED FINISHES**

Crystal Blue	<b>CYB</b>
Lime Green	<b>LMG</b>
Orange Flame	<b>ORF</b>
Steel Blue	<b>STB</b>
Vermilion Red	<b>VLR</b>

Accessory painted finishes are subject to 10% upcharge and minimum order of 50 pieces, orders under 50 pieces subject to \$500 net fee



**PANEL FABRICS – GRADE 1**

**Anchorage** - 35% Post - consumer Recycled Polyester and 65% Pre -consumer Recycled Polyester

Birch .....	<b>AN40</b>
Green Apple .....	<b>AN41</b>
Lapis .....	<b>AN42</b>
Straw .....	<b>AN43</b>
Wolf .....	<b>AN44</b>
Goose .....	<b>AN45</b>
Angora .....	<b>AN46</b>
Cumin .....	<b>AN47</b>
Asteriod .....	<b>AN48</b>
Geranium .....	<b>AN49</b>
Thistle .....	<b>AN50</b>
Graphite .....	<b>AN51</b>
Slate .....	<b>AN52</b>
Quarry Blue .....	<b>AN53</b>
Onyx .....	<b>AN54</b>
Pumpkin .....	<b>AN55</b>
Red Delicious .....	<b>AN56</b>
Sunshine .....	<b>AN57</b>
Magenta .....	<b>AN58</b>
Waterfall .....	<b>AN59</b>
Green Olive .....	<b>AN60</b>
Vanilla .....	<b>AN61</b>
Cobalt .....	<b>AN62</b>

**Birdseye** - 100% Recycled Polyester

Outlook .....	<b>BE21</b>
Rock .....	<b>BE22</b>
Vista .....	<b>BE23</b>
Soar .....	<b>BE24</b>
Impression .....	<b>BE25</b>
Glide .....	<b>BE26</b>
Panorama .....	<b>BE27</b>
Storm .....	<b>BE28</b>
Flight .....	<b>BE29</b>
Altitude .....	<b>BE30</b>

**Loopy** - 100% Recycled Polyester

Oyster .....	<b>LP60</b>
Putty .....	<b>LP61</b>
Marble .....	<b>LP62</b>
Hazelnut .....	<b>LP63</b>
Latte .....	<b>LP64</b>
Bay .....	<b>LP65</b>
Wild Rice .....	<b>LP66</b>
Harbor .....	<b>LP67</b>

**Melody** - 100% Recycled Polyester

Spray .....	<b>ME40</b>
Pond .....	<b>ME41</b>
Sand Bar .....	<b>ME42</b>
Silt .....	<b>ME43</b>
Pebble .....	<b>ME44</b>
Lake .....	<b>ME45</b>
Gravel .....	<b>ME46</b>
Boulder .....	<b>ME47</b>

**Meander** - 100% Polyester

Sandshell .....	<b>MN71</b>
Overcast .....	<b>MN72</b>
Agate Taupe .....	<b>MN73</b>

**Streak** - 100% Recycled Polyester

Camp .....	<b>SR80</b>
Beach .....	<b>SR81</b>
Stream .....	<b>SR82</b>
Stripe .....	<b>SR83</b>
Ridge .....	<b>SR84</b>
Beam .....	<b>SR85</b>
Shade .....	<b>SR86</b>
Ray .....	<b>SR87</b>

**Tek** - 100% Recycled Polyester

Finesse .....	<b>TX60</b>
Grain .....	<b>TX61</b>
Essence .....	<b>TX62</b>
Web .....	<b>TX63</b>
Warp .....	<b>TX64</b>
Nature .....	<b>TX65</b>
Wind .....	<b>TX66</b>
Mesh .....	<b>TX67</b>
Weave .....	<b>TX68</b>
Form .....	<b>TX69</b>

**Universe** - 100% Polyester

Milkyway .....	<b>UV01</b>
Crepe Brulee .....	<b>UV02</b>
Whitecap .....	<b>UV03</b>
Wheat .....	<b>UV04</b>
Seneca .....	<b>UV05</b>
Mica .....	<b>UV06</b>
Cosmic .....	<b>UV07</b>
Depth .....	<b>UV08</b>

**PANEL FABRICS – GRADE 2**

**Cyclone** - 56% post-consumer recycled polyester and 44% polyester.

Wrought Iron .....	<b>IM36</b>
Stove Pipe .....	<b>IM37</b>
Stainless .....	<b>IM40</b>
Polished Pewter .....	<b>IM41</b>
Welded Steel .....	<b>IM43</b>
Etched Bronze .....	<b>IM44</b>
Fired Titanium .....	<b>IM46</b>
Chrome .....	<b>IM49</b>
Dark Annealed .....	<b>IM50</b>
Karat .....	<b>IM54</b>
Red Metal .....	<b>IM55</b>
Oxidized Bronze .....	<b>IM56</b>
Bright Ray .....	<b>IM57</b>
Bismuth Crystal .....	<b>IM58</b>
Gallium Blue .....	<b>IM59</b>

**Frost** - 100% EcoPolyester

Dew .....	<b>FR30</b>
Earth .....	<b>FR31</b>
Blight .....	<b>FR32</b>
Chill .....	<b>FR34</b>

**Mesh** - 100% Recycled Polyester

Canyon .....	<b>B33A</b>
Napa Valley .....	<b>B34A</b>
Huntington .....	<b>B36A</b>
Huron .....	<b>B37A</b>
Heartland .....	<b>B39A</b>
Oat .....	<b>B81A</b>
Pepper .....	<b>B82A</b>
Limestone .....	<b>B84A</b>
Zinc .....	<b>B86A</b>

**Peripheral** - 100% Eco Polyester

Smut .....	<b>PE82</b>
Smudge .....	<b>PE83</b>
Coal .....	<b>PE84</b>
Ash .....	<b>PE85</b>
Cream .....	<b>PE86</b>
Powder .....	<b>PE87</b>



**GRADE 1 (VINYL)**

*For availability of chair series in Vinyl, please contact a Global Sales Representative.*

**Leatherite - 100% Polyvinyl Chloride / 100% Polyester Backing**

Light Grey .....	<b>66</b>
Charcoal .....	<b>67</b>
Dark Orange .....	<b>68</b>
Black .....	<b>70</b>
Chocolate .....	<b>79</b>
Soft Yellow .....	<b>80</b>
Bright Red .....	<b>81</b>
Pure White .....	<b>82</b>
Off White .....	<b>83</b>
Beige .....	<b>84</b>
Wheat .....	<b>85</b>
Golden Tan .....	<b>86</b>
Sage .....	<b>87</b>
Dark Green .....	<b>88</b>
Hunter .....	<b>89</b>
Purple .....	<b>90</b>
Purple Gray .....	<b>91</b>
Rose .....	<b>92</b>
Harbor Blue .....	<b>93</b>
Grey Blue .....	<b>94</b>
Royal .....	<b>95</b>
Midnight Blue .....	<b>96</b>
Cranberry .....	<b>97</b>
Dark Burgundy .....	<b>98</b>
Harvest .....	<b>99</b>
Cognac .....	<b>100</b>

**GRADE 3**

**Drama - 65% Olefin / 35% Polyester**

Grey .....	<b>D801</b>
Dusk .....	<b>D802</b>
Navy Blue .....	<b>D803</b>
Black .....	<b>D804</b>
Burgundy .....	<b>D805</b>
Sage .....	<b>D806</b>
Beige .....	<b>D807</b>
Denim Blue .....	<b>D808</b>
Wheat .....	<b>D809</b>
Tan .....	<b>D810</b>

**Jenny - 100% Polyester**

Midnite .....	<b>JN01</b>
Ebony .....	<b>JN02</b>
Slate .....	<b>JN03</b>
Russet .....	<b>JN04</b>
Canyon .....	<b>JN05</b>
Teal .....	<b>JN06</b>
Vermilion .....	<b>JN07</b>
Admiral .....	<b>JN08</b>
Spruce .....	<b>JN09</b>
Charcoal .....	<b>JN11</b>

**Mock Leather - 100% Polyvinyl Chloride**

Black .....	<b>550</b>
Chamois .....	<b>559</b>
Surf .....	<b>570</b>
Latte .....	<b>571</b>
Melon .....	<b>572</b>
Delta .....	<b>573</b>
Bronze .....	<b>574</b>
Rouge .....	<b>575</b>
Jade .....	<b>576</b>
Graphite .....	<b>577</b>
Chaps .....	<b>578</b>
Cabernet .....	<b>579</b>
Alpine .....	<b>591</b>

**Pebbles - 100% Polypropylene**

Clay .....	<b>PB01</b>
Fawn .....	<b>PB02</b>
Sea Side .....	<b>PB03</b>
Stone .....	<b>PB04</b>
Marine .....	<b>PB05</b>
Atrium .....	<b>PB06</b>
Rhapsody .....	<b>PB07</b>
Ocean .....	<b>PB08</b>
Asphalt .....	<b>PB09</b>

**Quilt - 100% Polyester**

Black .....	<b>QL10</b>
Charcoal Grey .....	<b>QL11</b>
Violet .....	<b>QL12</b>
Poppy .....	<b>QL13</b>
Navy .....	<b>QL14</b>
Marine .....	<b>QL15</b>
Wine .....	<b>QL16</b>
Mint .....	<b>QL17</b>
Forrest .....	<b>QL18</b>
Silver .....	<b>QL19</b>

**Shard - 62% Polyester / 38% Olefin**

Garnet .....	<b>SH11</b>
Bullion .....	<b>SH12</b>
Lagoon .....	<b>SH13</b>
Cypress .....	<b>SH14</b>
Java .....	<b>SH15</b>
Tempest .....	<b>SH16</b>
Arctic .....	<b>SH17</b>
Carbon .....	<b>SH18</b>

**Sprinkle - 68% Olefin / 32% Polyester**

Cabernet .....	<b>S101</b>
Plum .....	<b>S102</b>
Barley .....	<b>S103</b>
Copper .....	<b>S104</b>
Sapphire .....	<b>S106</b>
Jade .....	<b>S107</b>
Stone .....	<b>S108</b>
Cobalt .....	<b>S109</b>
Black .....	<b>S110</b>
Graphite .....	<b>S111</b>

**Station - 61% Recycled Polyester / 39% Polypropylene**

Green Olive .....	<b>SN81</b>
Sterling Silver .....	<b>SN82</b>
New Silver .....	<b>SN83</b>
Wheat .....	<b>SN84</b>
Sand .....	<b>SN85</b>
Sapphire .....	<b>SN86</b>
Tomato .....	<b>SN87</b>
Copper .....	<b>SN88</b>
Marine .....	<b>SN89</b>
Night Time .....	<b>SN90</b>
Charcoal .....	<b>SN91</b>
Taupe .....	<b>SN92</b>
Milk Chocolate .....	<b>SN93</b>

**Styx - 50% Polyester / 50% Viscose**

Spun Yarn .....	
Dark Navy .....	<b>ST10</b>
Charcoal .....	<b>ST11</b>
Midnite .....	<b>ST12</b>
Indigo .....	<b>ST13</b>
Tide .....	<b>ST14</b>
Burgundy .....	<b>ST15</b>
Barn .....	<b>ST16</b>
Pine .....	<b>ST17</b>
Granite .....	<b>ST18</b>
Glory .....	<b>ST19</b>
Olive .....	<b>ST20</b>
Moss .....	<b>ST21</b>

**Time 54% Polyester / 46% Polypropylene**

Leaf .....	<b>T601</b>
Picante .....	<b>T602</b>
Bamboo .....	<b>T603</b>
Fudge .....	<b>T604</b>
Aqua .....	<b>T605</b>
Sky .....	<b>T606</b>
Atmosphere .....	<b>T607</b>
Bordeaux .....	<b>T608</b>
Steel .....	<b>T609</b>
Midnight .....	<b>T610</b>

**Traditional Vinyl - 82% Plasticized Vinyl / 18% Polyester Backing**

Oxblood .....	<b>557</b>
Wedgewood Blue .....	<b>564</b>
Forest Green .....	<b>568</b>
Black .....	<b>569</b>

**Urban - 62% Recycled Polyester / 32% Polyester**

Red Rose .....	<b>UR10</b>
Ocean Blue .....	<b>UR11</b>
Blue Bayou .....	<b>UR12</b>
Green Grass .....	<b>UR13</b>
Sandcastle .....	<b>UR14</b>
Beach Day .....	<b>UR15</b>
Boardwalk .....	<b>UR16</b>
Earth .....	<b>UR17</b>
Brown Ridge .....	<b>UR18</b>
White Sand .....	<b>UR19</b>
Granite Rock .....	<b>UR20</b>
Gravel Road .....	<b>UR21</b>
Black Coal .....	<b>UR22</b>



**GRADE 4 (FABRIC)**

**Crescent** - 100% Nylon with Teflon  
Designed to color coordinate with  
Renewal and Quantum fabrics.

Cocoa.....	<b>700</b>
Pear.....	<b>701</b>
Silver.....	<b>702</b>
Oatmeal.....	<b>703</b>
Lemon.....	<b>704</b>
Flame.....	<b>705</b>
Stem.....	<b>706</b>
Ruby.....	<b>707</b>
Raven.....	<b>789</b>
Cobalt Blue.....	<b>790</b>
Cinder Grey.....	<b>792</b>
Pine.....	<b>799</b>
Arctic.....	<b>800</b>

**Cumulus** - 60% Recycled Polyester  
/ 40% Rayon with Teflon Designed  
to color coordinate with Oxygen and  
Silhouette fabrics.

Cinnamon.....	<b>CU80</b>
Sepia.....	<b>CU81</b>
Ginger.....	<b>CU82</b>
Steamboat.....	<b>CU83</b>
Coffee.....	<b>CU84</b>
Flora.....	<b>CU85</b>
Raven.....	<b>CU86</b>
Cyan.....	<b>CU87</b>
Foliage.....	<b>CU88</b>
Port.....	<b>CU89</b>

**Imprint** - 100% Post-Consumer  
Polyester

Almond.....	<b>IM70</b>
Cork.....	<b>IM71</b>
Sand.....	<b>IM72</b>
Currie.....	<b>IM73</b>
Candy Apple.....	<b>IM74</b>
Ocean.....	<b>IM75</b>
Navy.....	<b>IM76</b>
Green Tea.....	<b>IM77</b>
Celery.....	<b>IM78</b>
Oregano.....	<b>IM79</b>
Walnut.....	<b>IM80</b>
Paprika.....	<b>IM81</b>
Graphite.....	<b>IM82</b>
Slate.....	<b>IM83</b>
Licorice.....	<b>IM84</b>

**Match** - 100% Recycled Polyester

Desert.....	<b>MT20</b>
Sand.....	<b>MT21</b>
Moss.....	<b>MT22</b>
Orange.....	<b>MT23</b>
Sunset.....	<b>MT24</b>
Blue.....	<b>MT25</b>
Wave.....	<b>MT26</b>
Green.....	<b>MT27</b>
Chocolate.....	<b>MT28</b>
Burgundy.....	<b>MT29</b>
Grey.....	<b>MT30</b>
Quarry.....	<b>MT31</b>
Black.....	<b>MT32</b>
Arctic.....	<b>MT33</b>

**Oxygen** - 60% Recycled Polyester /  
40% Rayon with Teflon Designed to  
color coordinate with Cumulus and  
Silhouette fabrics.

Cabernet.....	<b>OX01</b>
Lime.....	<b>OX02</b>
Verde.....	<b>OX03</b>
Navy.....	<b>OX04</b>
Royal.....	<b>OX05</b>
Chestnut.....	<b>OX06</b>
Wine.....	<b>OX07</b>
Nutmeg.....	<b>OX08</b>
Sable.....	<b>OX09</b>
Nero.....	<b>OX10</b>

**Quantum** - 60% Recycled Polyester  
/ 40% Rayon with Teflon Designed to  
color coordinate with Crescent and  
Renewal fabrics.

Cinder.....	<b>QU20</b>
Copper.....	<b>QU21</b>
Carmel.....	<b>QU22</b>
Cantaloupe.....	<b>QU23</b>
Paprika.....	<b>QU24</b>
Blue Haven.....	<b>QU25</b>
Forest.....	<b>QU26</b>
Raspberry.....	<b>QU27</b>
Azure.....	<b>QU28</b>
Marbles.....	<b>QU29</b>

**Renewal** - 70% Nylon / 30% Recycled  
Polyester with Teflon Designed to  
color coordinate with Crescent and  
Quantum fabrics.

Pewter.....	<b>RN30</b>
Cork.....	<b>RN31</b>
Cherry Fields.....	<b>RN32</b>
Volcanic Ash.....	<b>RN33</b>
Thunderstorm.....	<b>RN34</b>
Blue Grass.....	<b>RN36</b>
Leaf.....	<b>RN38</b>
Melon.....	<b>RN39</b>
Blueberry.....	<b>RN40</b>
Blue Bayou.....	<b>RN41</b>
Tomato.....	<b>RN44</b>
Amethyst.....	<b>RN45</b>
Ochre.....	<b>RN47</b>

**Replay** - 100% Post-Consumer Recycled  
Polyester

Taupe.....	<b>RP20</b>
Caramel.....	<b>RP21</b>
Paprika.....	<b>RP22</b>
Wine.....	<b>RP23</b>
Ocean.....	<b>RP24</b>
Navy.....	<b>RP25</b>
Pistachio.....	<b>RP26</b>
Moss.....	<b>RP27</b>
Turquoise.....	<b>RP28</b>
Teal.....	<b>RP29</b>
Autumn.....	<b>RP30</b>
Dark Chocolate.....	<b>RP31</b>
Slate.....	<b>RP32</b>
Dove.....	<b>RP33</b>
Coal.....	<b>RP34</b>

**Silhouette** - 100% Nylon with Teflon  
Designed to color coordinate with  
Cumulus and Oxygen fabrics.

Asphalt.....	<b>SL20</b>
Acorn.....	<b>SL21</b>
Indigo.....	<b>SL22</b>
Shiraz.....	<b>SL23</b>
Verdant.....	<b>SL24</b>
Bronze.....	<b>SL25</b>
Camel.....	<b>SL26</b>
Jade.....	<b>SL27</b>
Sienna.....	<b>SL28</b>
Charcoal.....	<b>SL30</b>
Claret.....	<b>SL32</b>
Hunter.....	<b>SL35</b>
Sapphire.....	<b>SL36</b>

**GRADE 4 (VINYL)**

*For availability of chair series in  
Vinyl, please contact a Global Sales  
Representative.*

**Allante** - 100% Vinyl Face / 100%  
Polyester Backing

Cadet.....	<b>A01E</b>
Light Neutral.....	<b>A02E</b>
Charcoal.....	<b>A03E</b>
Regimental Blue.....	<b>A11E</b>
Galaxy.....	<b>A13E</b>
Burgundy.....	<b>A17E</b>
Wine.....	<b>A18E</b>
Nu-Red.....	<b>A19E</b>
Elephant.....	<b>A21E</b>
Cinnamon.....	<b>A22E</b>
Beach Wood.....	<b>A23E</b>
Teak.....	<b>A24E</b>
Light Sand.....	<b>A25E</b>
Cream.....	<b>A26E</b>
Medium Beige.....	<b>A27E</b>
Light Sandlewood.....	<b>A29E</b>
Light Parchment.....	<b>A31E</b>
Sea Oyster.....	<b>A32E</b>
Espresso.....	<b>A33E</b>
Medium Neutral.....	<b>A35E</b>
Nu-Antelope.....	<b>A36E</b>
Dark Pewter.....	<b>A38E</b>
Nu-Shale.....	<b>A40E</b>
Grey.....	<b>A41E</b>
Bisque.....	<b>A42E</b>
Black.....	<b>A43E</b>
Ash.....	<b>A44E</b>
Medium Grey.....	<b>A45E</b>
Pearl Grey.....	<b>A46E</b>
White.....	<b>A48E</b>
Tundra.....	<b>A49E</b>
Harvest.....	<b>A50E</b>
Magnolia.....	<b>A51E</b>
River Blue.....	<b>A52E</b>
Meadow.....	<b>A53E</b>
Hideaway.....	<b>A54E</b>
Sea Cruise.....	<b>A55E</b>
Reef.....	<b>A56E</b>
Parrot.....	<b>A57E</b>
Khaki.....	<b>A58E</b>
Tumbleweed.....	<b>A59E</b>
Cayenne.....	<b>A60E</b>
Butterscotch.....	<b>A61E</b>
Twine.....	<b>A62E</b>
Mango.....	<b>A63E</b>

**Softhide** - 100% Vinyl Face / 100%

Polyester Backing

Canary .....	<b>S030</b>
Sahara .....	<b>S031</b>
Spice .....	<b>S032</b>
Camel .....	<b>S033</b>
Saddle .....	<b>S034</b>
Cocoa .....	<b>S035</b>
Paprika .....	<b>S036</b>
Chipotle .....	<b>S037</b>
Casablanca .....	<b>S038</b>
Orbit .....	<b>S039</b>
Tangier .....	<b>S040</b>
Atlantic .....	<b>S041</b>
Vineyard .....	<b>S042</b>
Antique .....	<b>S043</b>
Palm .....	<b>S044</b>
White Sand .....	<b>S045</b>
Smoke .....	<b>S046</b>
Onyx.....	<b>S047</b>

**GRADE 5 (RECYCLED)**

**Abstract** - 100% Recycled Polyester

Designed to color coordinate with Identity and Cocktail fabrics.  
To Be Discontinued December 31, 2014

Lemon .....	<b>AB11</b>
Silver Mint .....	<b>AB12</b>
Ripe Tomato .....	<b>AB13</b>
Rhubarb .....	<b>AB14</b>
Green Pea .....	<b>AB15</b>
Spinach .....	<b>AB16</b>
Ice Water .....	<b>AB17</b>
Blueberry .....	<b>AB18</b>
Ochre .....	<b>AB19</b>
Chocolate .....	<b>AB20</b>

**Cocktail** - 100% Recycled Polyester

Designed to color coordinate with Identity and Abstract fabrics.  
To Be Discontinued December 31, 2014

Strawberry Daiquiri .....	<b>C030</b>
Pina Colada .....	<b>C031</b>
Electric Blue .....	<b>C032</b>
Grape Juice .....	<b>C033</b>
Blueberry Soda .....	<b>C034</b>
Earl Grey .....	<b>C035</b>
Caesar .....	<b>C036</b>
Olive Green .....	<b>C037</b>
Green Tea .....	<b>C038</b>
Black Tea .....	<b>C039</b>

**GRADE 5 (RECYCLED) CONTINUED**

**Couture** - 100% Post-Consumer

Polyester

Champagne .....	<b>CE70</b>
Mocha .....	<b>CE71</b>
Pecan .....	<b>CE72</b>
Raspberry .....	<b>CE73</b>
Sapphire .....	<b>CE74</b>
Neptune.....	<b>CE75</b>
Lake .....	<b>CE76</b>
Willow.....	<b>CE77</b>
Sassy.....	<b>CE78</b>
Fudge.....	<b>CE79</b>
Persimmon.....	<b>CE80</b>
Carbon.....	<b>CE81</b>
Sterling.....	<b>CE82</b>
Peat .....	<b>CE83</b>

**Identity** - 100% Recycled Polyester

Designed to color coordinate with Abstract and Cocktail fabrics.  
To Be Discontinued December 31, 2014

Blue .....	<b>ID01</b>
Plum.....	<b>ID02</b>
Cypress.....	<b>ID03</b>
Cobalt.....	<b>ID04</b>
Poppy.....	<b>ID05</b>
Lava .....	<b>ID06</b>
Baltic .....	<b>ID08</b>
Wheat.....	<b>ID11</b>
Spring.....	<b>ID12</b>
Peridot.....	<b>ID13</b>
Garnet.....	<b>ID14</b>
Espresso.....	<b>ID16</b>
Grey.....	<b>ID17</b>

**GRADE 6**

**Presidio** - 100% Nylon with Teflon

Saffron.....	<b>PR01</b>
Light Grey.....	<b>PR02</b>
Charcoal .....	<b>PR03</b>
Loden.....	<b>PR04</b>
Persian.....	<b>PR05</b>
Mallard.....	<b>PR06</b>
Thistle.....	<b>PR07</b>
Campari .....	<b>PR08</b>
Cranberry.....	<b>PR09</b>
Eggplant .....	<b>PR10</b>
Cobalt Blue.....	<b>PR11</b>
Onyx.....	<b>PR12</b>

**GRADE 7**

**Genuine Leather/Mock Leather**

**combinations** - 100% Leather / 100% Polyvinyl Chloride

Black.....	<b>450/550</b>
Chamois.....	<b>459/559</b>
Surf.....	<b>470/570</b>
Latte .....	<b>471/571</b>
Melon.....	<b>472/572</b>
Delta.....	<b>473/573</b>
Bronze.....	<b>474/574</b>
Rouge.....	<b>475/575</b>
Jade.....	<b>476/576</b>
Graphite.....	<b>477/577</b>
Chaps.....	<b>478/578</b>
Cabernet.....	<b>479/579</b>
Alpine.....	<b>491/591</b>

**GRADE 10**

**Genuine Leather** 100% Leather

Black.....	<b>450</b>
Chamois.....	<b>459</b>
Surf.....	<b>470</b>
Latte .....	<b>471</b>
Melon.....	<b>472</b>
Delta.....	<b>473</b>
Bronze.....	<b>474</b>
Rouge .....	<b>475</b>
Jade.....	<b>476</b>
Graphite.....	<b>477</b>
Chaps.....	<b>478</b>
Cabernet.....	<b>479</b>
Alpine.....	<b>491</b>

**GRADE 12**

**Contract Leather** 100% Leather

Havana .....	D530
Dark Brown.....	D531
Sage .....	D532
Taupe.....	D533
Black.....	D534
Mustard.....	D535
Dark Green .....	D537
Burgundy .....	D538
Chestnut.....	D540
Charcoal .....	D541



# PANEL COM REQUEST FOR APPLICATION TEST

## SEND COMPLETED FORM AND FABRIC TO:

Compile Customer Service  
555 Petrolia Road  
Toronto, Ontario M3J2X8  
Phone: 416.739.5000

Requested By: \_\_\_\_\_  
\_\_\_\_\_

Phone #: \_\_\_\_\_

Fax #: \_\_\_\_\_  
\_\_\_\_\_

Dealer/Specifier  
\_\_\_\_\_  
\_\_\_\_\_

Dealer Contact: \_\_\_\_\_

Evolve CSR: \_\_\_\_\_  
\_\_\_\_\_

Phone #: \_\_\_\_\_

Fax #: \_\_\_\_\_  
\_\_\_\_\_

## FABRIC INFORMATION

Fabric Manufacturer: \_\_\_\_\_  
\_\_\_\_\_

Color Name: \_\_\_\_\_

Color #: \_\_\_\_\_  
\_\_\_\_\_

Pattern Name: \_\_\_\_\_

Pattern #: \_\_\_\_\_  
\_\_\_\_\_

Content: \_\_\_\_\_  
\_\_\_\_\_

Weight: \_\_\_\_\_

Width: \_\_\_\_\_  
\_\_\_\_\_

Repeat Horizontal: \_\_\_\_\_

Repeat Vertical: \_\_\_\_\_  
\_\_\_\_\_

Other Comments: \_\_\_\_\_  
\_\_\_\_\_

## REQUEST FOR APPLICATION TEST (THIS REQUIRES 2 YARDS OF FABRIC)

\_\_\_\_\_ Compile Panel

\_\_\_\_\_ Compile Tackboard

Total Number of yards for testing: \_\_\_\_\_

Please Note:

Compile is not responsible for the duty and brokerage fees for C.O.M. Fabric to clear customs. These charges will be billed to the dealer on a separate invoice.

# PANEL FABRIC SPECIFICATION SHEET

**SEND COMPLETED FORM TO:**

Compile Customer Support  
 555 Petrolia Road  
 Toronto, Ontario M3J2X8  
 Phone: 416.739.5000

<b>SUPPLIER</b>  <b>PATTERN</b>  <b>WIDTH</b>  <b>CONTENT</b>	<b>REMARKS:</b> _____ _____ _____ _____	
<b>LIGHT FASTNESS</b>  <b>FLAMMABILITY</b>  <b>TUNNER TEST</b>	<b>REMARKS:</b> _____ _____ _____ _____	
<b>CUT PRICE</b>  <b>1 - 3 ROLLS</b>  <b>4 ROLLS</b>	<b>REMARKS:</b> _____ _____ _____ _____	
<b>DIRECTIONAL</b>  <b>PANELS CORNERS</b>  <b>RACEWAY COVER</b>  <b>RACEWAY CORNERS</b>  <b>STRETCH</b>	<b>REMARKS:</b> _____ _____ _____ _____	<b>EASY</b> <b>HARD</b> <b>X-HARD</b>
<b>APPROVED</b> <input type="checkbox"/> <b>NOT APPROVED</b> <input type="checkbox"/> <b>CONDITIONAL APPROVAL</b> <input type="checkbox"/>		
<b>REMARKS:</b> _____ _____ _____		
* This fabric is approved for upholster-ability only. The approval does not account for the durability of the fabric at the time of, and after installation of the product		
<b>APPROVAL SIGNATURE:</b> _____		<b>DATE:</b> _____

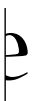

# C.O.M AUTHORIZATION FORM FOR COMPILE PEDESTAL CUSHIONS

## CUSTOMER INFORMATION

To be completed by the dealer/design firm. Use one form per textile. Incomplete information may delay or prevent approval.

A+D/Dealer/Company Name:		Contact:	Date:
Billing Address:		Phone:	
City:	State:	Zip:	Fax:
End-User/Project Name:		End-User/Project Registered? YES NO If YES, The Evolve Quote#:	

## TEXTILE APPLICATION INFORMATION

MODEL NUMBER	QUANTITY	SPECIAL INSTRUCTIONS

Textile Name (Series/Style #):

Textile Color Name and Description:

Country of Origin:

Mill or Manufacturer's Name:

Textile Content (% Cotton, % Poly, % Wool, etc.):

Textile Width:                                  Pattern Repeat: VERTICAL HORIZONTAL                                  Rail Roaded? YES NO

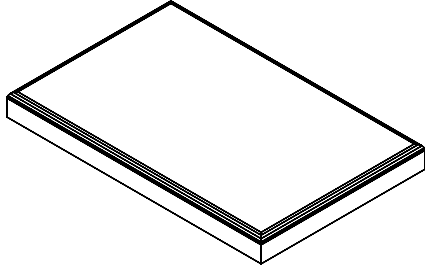
TEXTILE DIRECTION	NEW TEXTILE	PREVIOUSLY APPROVED TEXTILE
 <p><b>STAPLE FABRIC TO THIS FORM IN THE DIRECTION IN WHICH THE FABRIC IS TO BE UPHOLSTERED WITH THE LEFT SIDE OF THIS PAGE BEING THE SAME LEFT AS THE CUSHION.</b></p>	<p>Attached textile sample (Minimum 5" x 5" Max 12" x 12") In correct DIRECTION and SIDE.</p>	<p>Fax completed form to: 856.596.5684</p>
	<p><b>MAIL FORM AND TEXTILE SAMPLE ONLY TO:</b> GLOBAL - COM Department 17 West Stow Road Marlton, NJ 08053   856.596.3390</p>	
	<p>Please contact your local EVOLVE CustomerCare representative for status of all COM requests. When textile is approved and an authorization number issued, a set of shipping instructions will be faxed or e-mailed to you.</p> <p>Approved textiles are to be shipped to the address that will be included with instructions. Do not ship textiles to the address on this form. Dealer is responsible for the shipping expenses. Brokerage fees will be paid for by Global. However, duties imposed by North American Governments related to textile materials, content and Country of Origin, additional fees may apply and will be billed separately.</p> <p>Please Note: C.O.M Textiles may not be shipped without shipping documents. GLOBAL is not responsible for any material shipped without the authorization number.</p> <p><b>Please be advised that Global has phased out the use of textiles that contain certain Phthalates, including but not limited to: DEHP ( di (2-ethylhexyl) phthalate), DBP (di-n-butyl phthalate), BBP (butyl benzyl phthalate) and DINP (di-isononyl phthalate) (collectively the "Listed Chemicals"). The Listed Chemicals are used in certain types of vinyls. Global cannot accept orders for textiles that contain the Listed Chemicals, if such orders are to be shipped to the U.S.A. or are intended for customer in the U.S.A. If you are not sure if the C.O.M you have selected contains the Listed Chemicals, please contact the manufacturer or supplier of the fabric to verify.</b></p>	

## EVOLVE AUTHORIZATION FORM (TO BE COMPLETED BY CUSTOMERCARE REP.)

CAN#:	TEXTILE YARDAGE (REQUIRED FOR THE ORDER):	GU CODE:
SIGNATURE: _____	PRINT NAME: _____	DATE: _____

**PANEL FABRIC SAMPLE**

**TOP**

**STAPLE  
MINIMUM 6" X 6"  
FABRIC SAMPLE HERE  
IN THE DIRECTION IT IS TO BE  
APPLIED TO THE PRODUCT**

**BOTTOM**



# APPENDIX

The Evolve Furniture Group has partnered with the software vendors listed below to provide you with an online source for viewing the 2014 Compile Electronic Catalog. Please visit their websites for additional information and download details.

## **2020 Technologies**

www.2020technologies.com  
5503 Mile Road NW  
Grand Rapids, MI 49544  
Phone: 800-638-6002

## **Ice Edge Business Solutions**

www.ice-edge.com  
4001 S 700 East, Suite 450  
Salt Lake City, UT 84107  
Phone: 801-747-0373

## **KISP**

www.kisp.com  
Customer Support: 416-499-2457  
Cad Services Team: 416-499-2457 x3  
Customer Service e-mail: tellmemore@kisp.com  
CAD Services requests CadServices@kispstech.com

## **Project Matrix**

www.projectmatrix.com  
11655 Lebanon Rd.  
Cincinnati, OH 45241  
Tech Support Instant Messenger: projectmatrixtech@yahoo.com  
Phone: 513.554.1665  
Fax: 513.554.1255

## **Quintero-Smith Incorporated/Midnight Oil**

www.midnight-oil.com  
10469 Kinnard Avenue  
Los Angeles, CA 90024  
voice: 800-350-7434 (US Only)  
international: 310-478-5140  
fax: 310-478-4572  
e-mail: jimrsr@q-si.com





# TERMS & CONDITIONS

## APPLICATION OF STANDARD TERMS

Sales of Evolve products are made only on Evolve standard terms and conditions of sale which are contained in the Price Book and in Evolve's order acknowledgments. These standard terms and conditions may be modified or supplemented only by a separately written document signed by Evolve's authorized personnel at its head office in Marlton, New Jersey. An offer by Purchaser of said terms and conditions shall not be binding until accepted by Evolve in writing.

All illustrations, specifications and prices in this Price List are based on the latest product information available at the time of publication. Evolve reserves the right to make changes, at any time and without prior notice, to prices, colors, materials, specifications and models offered.

## PRICES AND PAYMENT

The prices shown in this Price List, as well as those quoted by Evolve, shall be in US dollars for orders shipped to destinations within the continental United States.

Prices listed herein are for standard product. Quotations for special product are available through Evolve Customer Support Department in Marlton, New Jersey.

If shipping date requested is more than 90 days from date of order Evolve shall use published list prices effective at the time of shipment.

Not included in the list price are special or export packing, unpacking and installation. Orders are invoiced at the time of shipment. The Customer agrees to pay a charge of 2% per month of invoices outstanding more than 30 days.

## FOR PAYMENTS ONLY, MAIL TO:

Evolve Furniture Group, a division of:  
Global Industries, Inc.  
17 West Stow Road  
P.O. Box 562  
Marlton, New Jersey 08053

Any products sold shall remain the property of Evolve until fully paid for in cash. The Purchaser agrees to perform all acts which may be necessary to perfect and assure retention of title to such products to Evolve until such time as the goods have been paid for in full.

Freight charges will be prepaid by Evolve to destinations within the contiguous United States on orders of \$10,000 list and greater. For purchase orders less than \$10,000 list, the freight charge will be 5% of the total list price.

Please note exception below:

**All showroom and mock-up orders will be subject to actual freight charges.**

Evolve shall, in its sole discretion, determine the most appropriate method of shipment routing and carrier. Shipments of less than a full trailer load (LTL) shall ship via common carrier. **These LTL shipments are not subject to specific delivery days or times.** Full trailer loads will provide for dedicated delivery time and schedule. Purchaser may request special packaging or method of shipment at Purchaser's sole expense.

## TAXES

All sales, use, excise and other applicable taxes and the collection and reporting thereof (excluding only taxes on the net income of Evolve) are the Purchaser's responsibility and will be invoiced to the Purchaser. If Purchaser claims an exemption from such taxes, it shall be the Purchaser's responsibility to furnish an appropriate exemption certificate to Evolve.

## ORDER INFORMATION

Evolve requires that **all orders be submitted in writing** to avoid errors and/or duplication. Orders will be acknowledged with Evolve's acknowledgement forms governing the transaction. The details appearing on the acknowledgement will describe the items to be shipped to Purchaser who must ascertain that they are correct. If not correct, Purchaser should notify Evolve immediately by telephone or fax followed by written confirmation. Acknowledgment shows approximate shipping date of items ordered. **Shipping dates are assigned to orders based on the item having the longest manufacturing lead time.** Orders with Customer's Own Material (C.O.M.), or missing or incorrect information (finish selections, fabric selections, etc.) will be scheduled for manufacturing upon receipt of COM or correct complete information. Purchaser must indicate if multiple shipping schedules are required including noting if the shipping date requested is longer than standard posted lead time. Each shipment will be invoiced at time of shipping and will be subject to payment terms described herein.

## C.O.M. CUSTOMER'S OWN MATERIAL

Should Purchaser request a fabric, not standard to the Evolve upholstery line, Purchaser shall submit a sample of not less than two yards for approval. Evolve will determine whether fabric is suitable to manufacturing process and applicable UL or code requirements. Should Evolve be required to test such fabric, it shall so advise Purchaser, and Purchaser shall be responsible for all costs associated therewith. This includes all duty and brokerage fees.

Fabric yardage requirement will be determined by Evolve. An additional charge may be made to cover the cost of cutting, matching or sewing unusual or directional patterns. Evolve shall have no responsibility for condition, quality, performance, physical properties or any other aspect of C.O.M. For panels, price as if grade 1 fabric is used.

Evolve reserves the right to reject any C.O.M. deemed unsuitable.

Evolve reserves the right to cancel an order at any time if C.O.M. is, in the sole judgement of Evolve, inadequate for any reason.

## CHANGES AND CANCELLATION

The order may not be changed or cancelled by Purchaser without the written consent of Evolve. This charge can be as much as 100% based upon proximity to scheduled shipment date. Special order items and fabric-covered items already in production are not subject to change or cancellation under any circumstances. Fabric-covered items are considered to be in production once the fabric has been cut.

## DEPOSIT ON SPECIAL ORDERS

Orders for nonstandard products may, at Evolve's discretion, require deposit prior to scheduling of production, the amount of the deposit being credited against the total price of the project.

## SUSPENSION

In the event that the Purchaser defaults in the payment of any sum due Evolve, or in the event the Purchaser's financial condition becomes unsatisfactory to Evolve, Evolve shall have the right at its option, upon written notice to the Purchaser, to cancel shipment of any goods, unless within ten (10) days of Purchaser's receipt of such notice Purchaser provides assurance of payment to Evolve in such form, content and/or amounts as Evolve, in its sole discretion, deems adequate.

## COMBINED SHIPMENTS

Evolve will make every effort to combine shipments and orders on written request. However, acceptance of such request shall be with Evolve's sole discretion.

## CODE RESTRICTIONS

Evolve portable furniture may be subject to local fire, electrical and/or building codes applicable to portable furniture. It shall be Purchaser's sole responsibility for the proper application of Evolve items within the limitations of such local codes, which may be different from area to area.

## SERVICE

Service problems shall be handled by the authorized Evolve dealer. Where this cannot be accomplished on a local level, service problems should be referred to:

Evolve Furniture Group  
Customer Support  
17 West Stow Road  
Marlton, New Jersey USA 08053  
856-552-4000 888-827-2500  
Attention: Evolve Operations Manager



# TERMS & CONDITIONS

## STORAGE

In the event Purchaser requests postponement of delivery beyond the acknowledged shipping date, Evolve may transfer the goods to storage on Purchaser's account and at Purchaser's risk and expense subject to a daily storage rate. Such transfer to storage shall be deemed shipment to Purchaser for all purposes, including invoicing and payment.

## DELAYS

Evolve's order acknowledgement will state a shipping date which is Evolve's best estimate at the time the order is acknowledged. However, Evolve shall not incur any obligation or liability to Purchaser for failure to ship by a specified date. In addition, Evolve shall not be liable for any loss or damage resulting from any delay or failure in shipment or other failure to perform all or any part of the agreement between the parties with respect to the goods shown on the face of the order acknowledgement where such delay, failure, loss or damage is the proximate result of any act of any governmental authority or political subdivision thereof, revolution, riot, civil disorder or disturbance, act of enemies, delay or default in transportation, strike disputes among or between unions or other labor disputes, delay or inability in obtaining materials and facilities, fire, flood, act of God or any cause not within the reasonable control of Evolve, whether of the class of causes enumerated or otherwise. Without limiting the generality of the foregoing, Evolve may, without causing any breach or incurring liability, allocate goods which are in short supply, regardless of the reasons therefore, among purchasers, in any manner which Evolve, in its sole discretion, deems advisable.

## BACK CHARGES

Evolve will not accept charges for expense incurred by the Purchaser in expediting shipments or otherwise. Evolve will not accept charges for the repair of damage by others.

## CLAIMS

All goods are sold F.O.B. Toronto, Canada, unless otherwise agreed to in writing by Evolve. Evolve is not responsible for damage which occurs in transit or in storage. The carrier signs for all goods received in good order. It is the Purchaser's responsibility to examine goods upon receipt and to file any claims with the carrier. Any claims made against Evolve for apparent defects, errors or shortages must be made by the Purchaser in writing, within fifteen (15) working days after any delivery. Failure by the Purchaser to make any claim against Evolve within the above-described ten days shall constitute acceptance of the goods and a waiver of any apparent defects, errors or shortages.

## RETURNS

No returns of goods will be accepted without written consent and shipping instructions, including Evolve's Return Goods Authorization (R.G.A.) numbers, to Evolve. A minimum restocking charge of 35% is made on all authorized returns for credit or refund, provided goods are received by Evolve in the condition in which they left the factory. No credit will be given if goods cannot be reused. Special order items and fabric-covered items are in no event subject to return. All returns must be approved and authorized in writing by Evolve Customer Support, Marlton, New Jersey.

## LIFETIME WARRANTY

Evolve warrants that all commercial products are free from defects in material and workmanship, for the life of the product, to the original purchaser. This warranty is made by Evolve only to original customers acquiring the product directly from Evolve's authorized dealers. The customer's sole remedy pursuant to this warranty is limited to repair or replacement of parts or product at Evolve's option. Consent from Evolve must be obtained before any warranty work is performed. This warranty shall not apply to any products which must be replaced because of normal wear and tear, negligence, abuse or "accident", shipping damage, or product use and installation other than in accordance with written instructions or warnings. It shall also not apply when product has been modified or altered, repaired or refurbished by someone other than Evolve or an authorized dealer or because of natural variations over which Evolve has no control. In the event of repair and/or replacement of any defective product, Evolve does not warrant matching color, grain, texture or dye lots. Evolve's warranty does not cover the cost of transportation or labor. Repair or replacement will be at Evolve's option. Evolve makes no warranty that any of its products are suitable for any particular purpose and makes no other warranties, expressed or implied, other than those set forth in this Price List. As codes and standards vary from one jurisdiction to another, references to compliance are solely for convenience and without any representation as to accuracy or suitability. Users must verify the suitability of such information or product for their specific application. In no event shall Evolve be liable in either tort or contract for any loss or direct, special, incidental, consequential, or exemplary damages.

This Lifetime Warranty is NOT applicable to customers who use Evolve products for rental purposes and is effective only for products, parts or components manufactured after January 1, 2011.

Exceptions to this warranty include:

- Global fabrics and wood veneers, which are warranted for five years from date of delivery.
- Electrical components, which are warranted for ten years from the date of delivery.
- Moving parts such as glides, slides, casters, user-adjustable worksurface mechanisms, which are warranted for five years from date of delivery.

- Fading on fabric and wood veneers can be caused by exposure to U.V. rays/sunlight. Natural wood veneer, being a natural material, will have shade differences between veneer sheers, the difference will be more apparent between dye lots.

Evolve does not warrant color fastness on Customer's Own Material.

Because of natural variations over which Evolve has no control, this warranty does not extend to color, grain or texture of wood, and Evolve does not warrant matching of color, grain or texture.

Evolve makes no warranties, including implied warranties of merchantability and fitness for a particular purpose, other than the express warranties contained herein.

## LIMITATION OF REMEDY

Purchaser's sole and exclusive remedy (excluding the repair or replacement of goods for breach of the express warranty above) for any matter or claim arising under or relating to these terms and conditions, the goods covered hereby and any transaction involving or relating to such goods, whether in contract, tort (including negligence) or otherwise, shall be payment of the lesser of the cost to repair or replace said product or the purchase price for the goods to which the claim relates. In no event shall Evolve be liable for any special, indirect, consequential, or incidental damages, including without limitation, damages for loss of business profits, business interruptions, or loss of information.

## EVOLVE'S WARRANTY DOES NOT APPLY (FOR ANY PRODUCT CATEGORY) TO THE FOLLOWING:

- Failures due to wear and tear
- Failures which result from negligence, abuse, accident or misuse
- Failure to apply, install or maintain products according to Evolve's written instructions and warnings
- Modifications, attachments or repair methods not approved by Evolve
- Damage caused by a carrier in transit, or delivery/installation contractors
- The matching of colors, grains or textures (wood, leather, etc.) of natural materials and color matching of textiles
- Products exposed to extreme hot or cold temperatures or excessively dry or humid environments
- Colorfastness or the matching of color of textiles
- Damage by markings or staining; damage by sharp objects or imprinting from instruments
- Damage to textiles or laminate and wood surfaces/edges from exposure to sunlight (including UV rays)
- Products used for rental purposes

Evolve's warranty applies to products sold within the United States of America, Mexico, the Commonwealth of Puerto Rico and Canada.

**Evolve Furniture Group**

17 West Stow Rd. P.O. Box 562 Marlton, New Jersey USA 08053 T 856•552•4000 888•827•2500 F 856•552•4001 [evolvefurnituregroup.com](http://evolvefurnituregroup.com)

